



Mobile Distributed C4ISR Architecture (MDCA)

Presentation to NDIA

14th Systems Engineering Conference 2011



What does the Warfighter Need?

- Warfighters have to deal with layers of black boxes, controls and displays --in different formats and interfaces, with disparate capabilities and functionalities—on one platform.
- Developers build similar capabilities repeatedly ---we buy platform-unique, “closed architecture” hardware and software.
- Training becomes less applicable “platform to platform”
- **The operator , who often works across different systems and platforms on a single mission--“is” the integrator**
- We are designing in “scheduled obsolescence” and increasing the cost of sustaining and upgrading legacy systems.
- Not planning for the utility and adaptability that future automated and networked platforms and systems will enable

We need a different approach

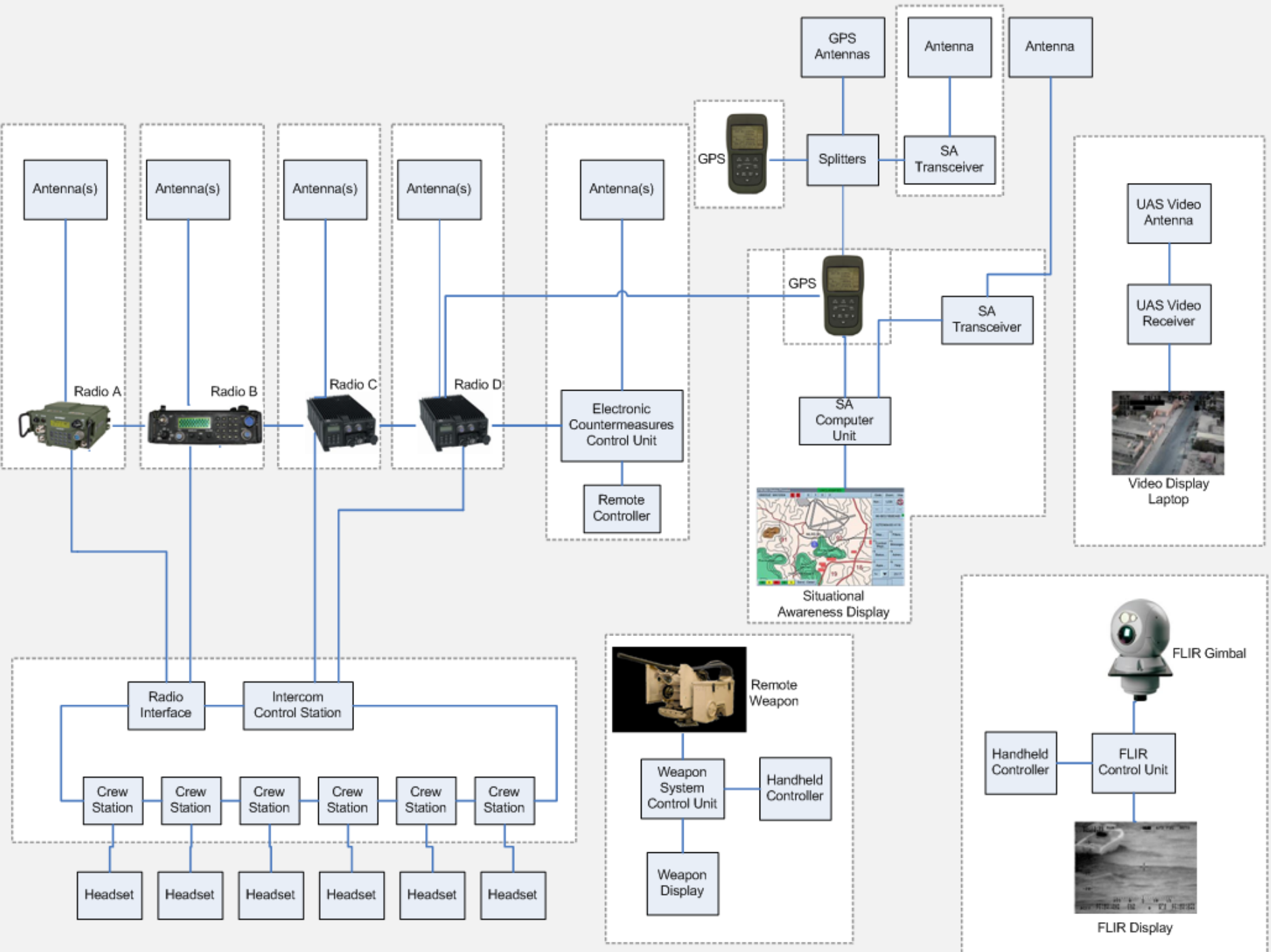



Functional Flow Block Diagram (Shuttle Radar)

TOP LEVEL

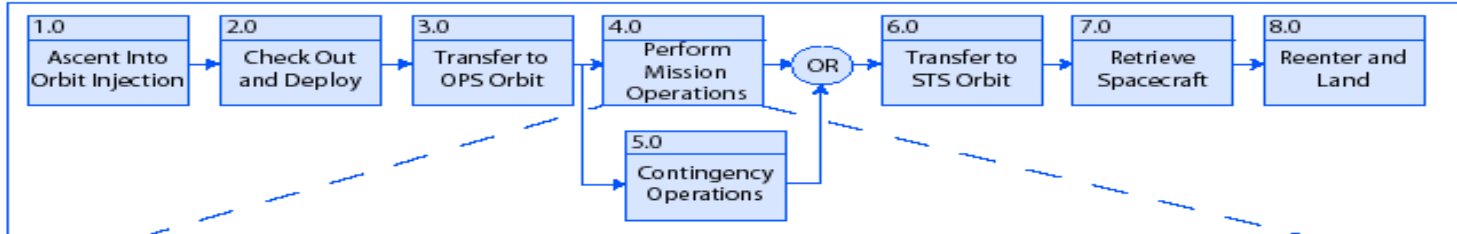

SECOND LEVEL

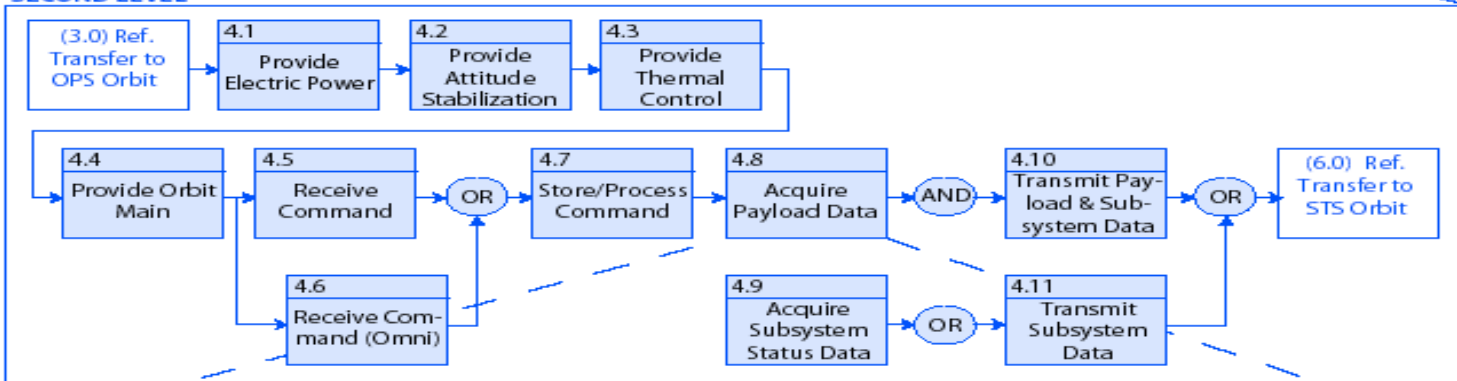

THIRD LEVEL

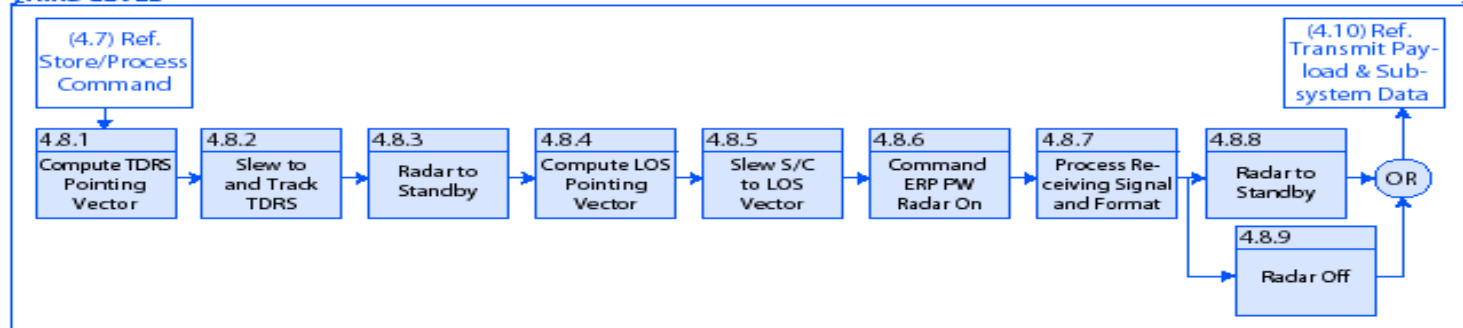



Problem:

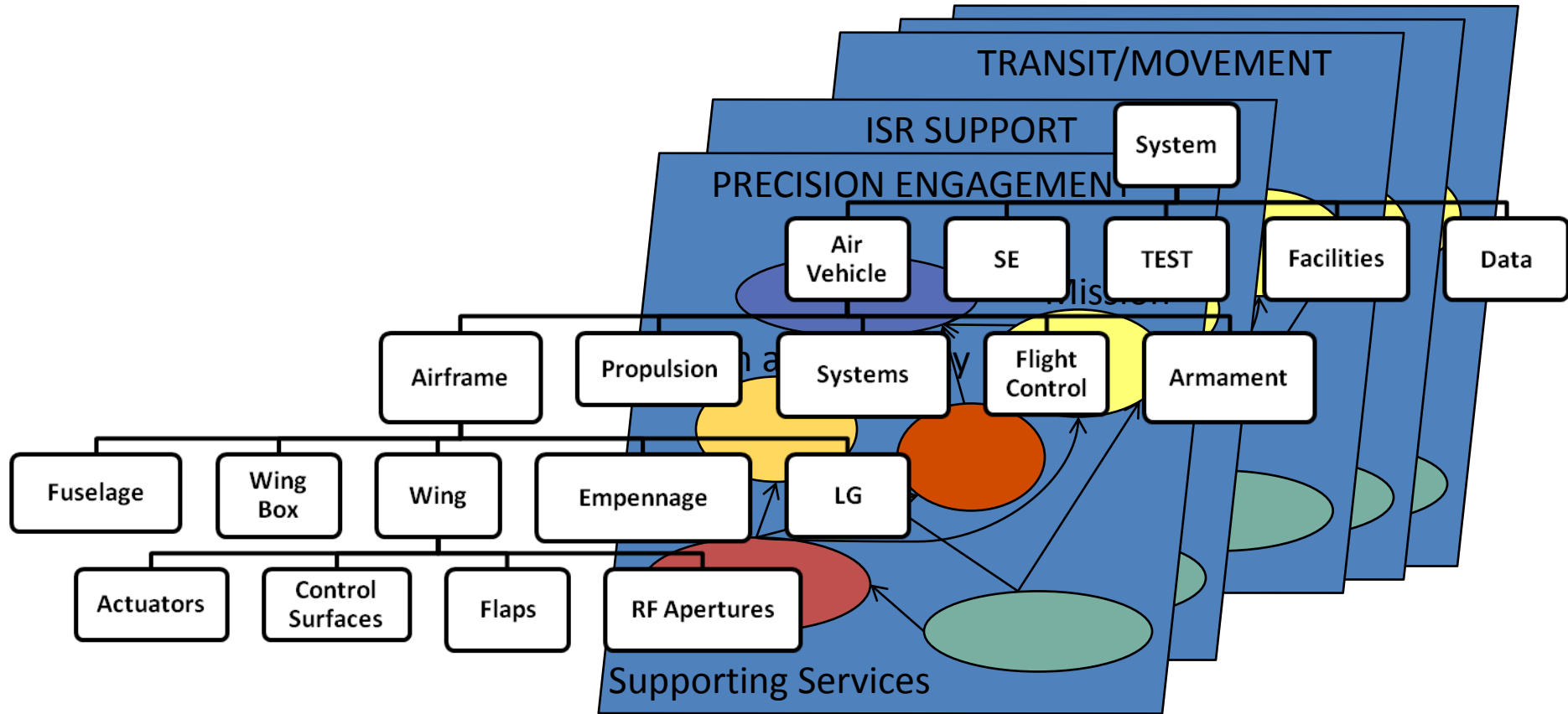

Need to link Functional Hierarchy to Physical Domain



What Capabilities are “Inbound”?

- 4G Wireless Base Stations
- “The Cloud” and “Land ISR Net”
- Defensive systems (GPR, EMP, Interceptors)
- Bridges to Dismounts
- Helmet Mounted Displays
- Shared SA
- Geo Location
- UAS local control
- Advanced Weapon FCS
- “Pilot Advocates”



What is Needed

1. Systems built with the “Operator” as the “Customer”
2. An architecture to accommodate different platforms, environments, capabilities, missions
3. “Attributes” —
 - a. Standards which industry will embrace
IEEE, NEMA, others
 - b. A “taxonomy” --- Common definitions
 - c. Open Architecture to describe systems and platform capabilities
 - d. Propelled by Commercial markets and applications
 - e. Easy to certify and introduce changes



Mobile Distributed C4ISR Architecture (MDCA)

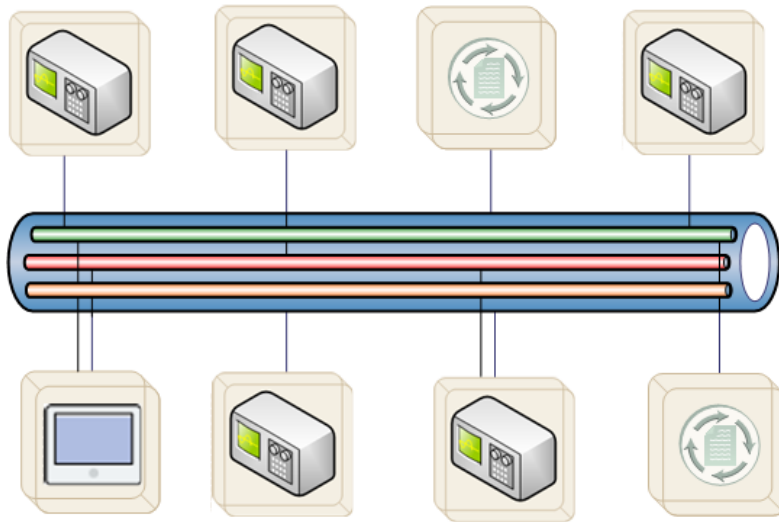

- Distributed processing and control
- Scalable
- Abstraction of devices and software as services with standard interfaces
- Loose coupling of services
- Modular User Interface decoupled from devices

Goals and Objectives

- Common Architecture design for C4ISR integration on various platforms
- Open industry standards
- SWAP reduction
- Lifecycle cost savings
- Increased Interoperability

Outputs

- Technical Data Package (TDP)
- Development and Test Lab



MDCA Layers

- **Application Layer**
 - User Interface Specifications
- **Functional Layer**
 - Utility Services (Time, Location, Velocity, etc.)
 - Data Storage & Data Recording
- **Core Interoperability Layer**
 - Plug and Play
 - Discovery
 - Management & Configuration
- **Physical Layer**
 - Connectors & Cabling
 - SWAP & Environmental Requirements

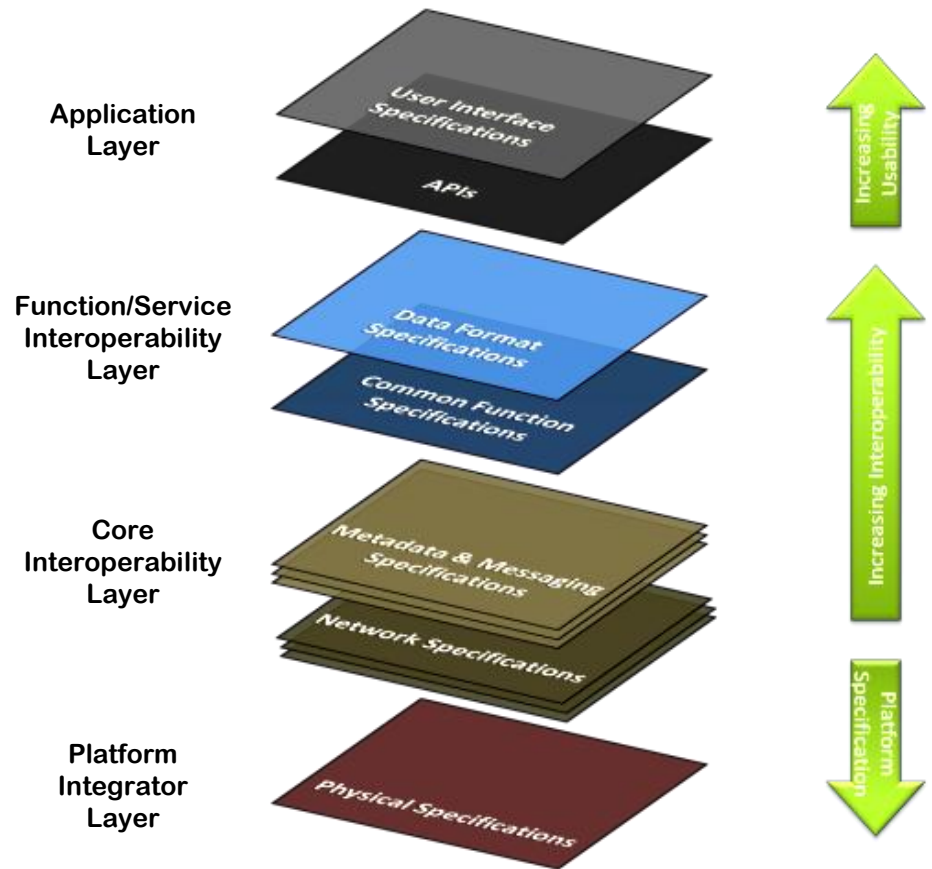



NAVAIR Testbed

- Testbed available to government and industry for integration, compliance and performance testing

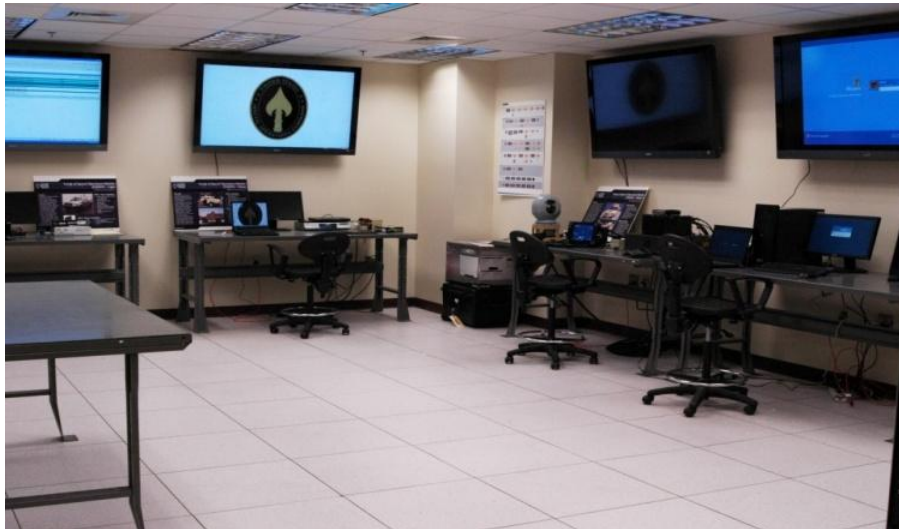

- Make it easy to develop, test, certify and introduce changes
 - Capabilities and components “purple” tested



Benefits of MDCA Approach

- Allows new capabilities—across multiple platforms and programs
 - Location aware applications
 - Sensor fusion
 - “Slew to cue”
 - Augmented reality
 - User-defined operator interfaces
 - Automated logistics
 - Supporting unintended uses – “Mashups”
- Better Tools, Training
- More Sustainable and Upgradable
- Supports future Conventional + Irregular Warfare capabilities

More Performance from Crews and Systems



Challenges

- Imperfect and evolving operational requirements
- Mixing/Separating physical and functional constraints among subsystems
 - Multiple program of record systems
- Alignment of government-led open architecture initiatives
 - Avoiding format wars
- Choice vs. complexity
- Interoperability vs. Flexibility
- Defining “Open”
- Developing attractive business models
 - Equipment manufacturers
 - System integrators
 - Application developers



Contact Info

William Jago

Electronics Engineer

NAVAIR Special Communications Requirements
Division

william.jago@navy.mil

301-995-8034

William Shepherd

Advisor

274152@gmail.com

757-285-2633