



AMMO FUNDING

Mr. Don Chrans
Army G8 / FDX Munitions Division

February 2010



How Ammo Works

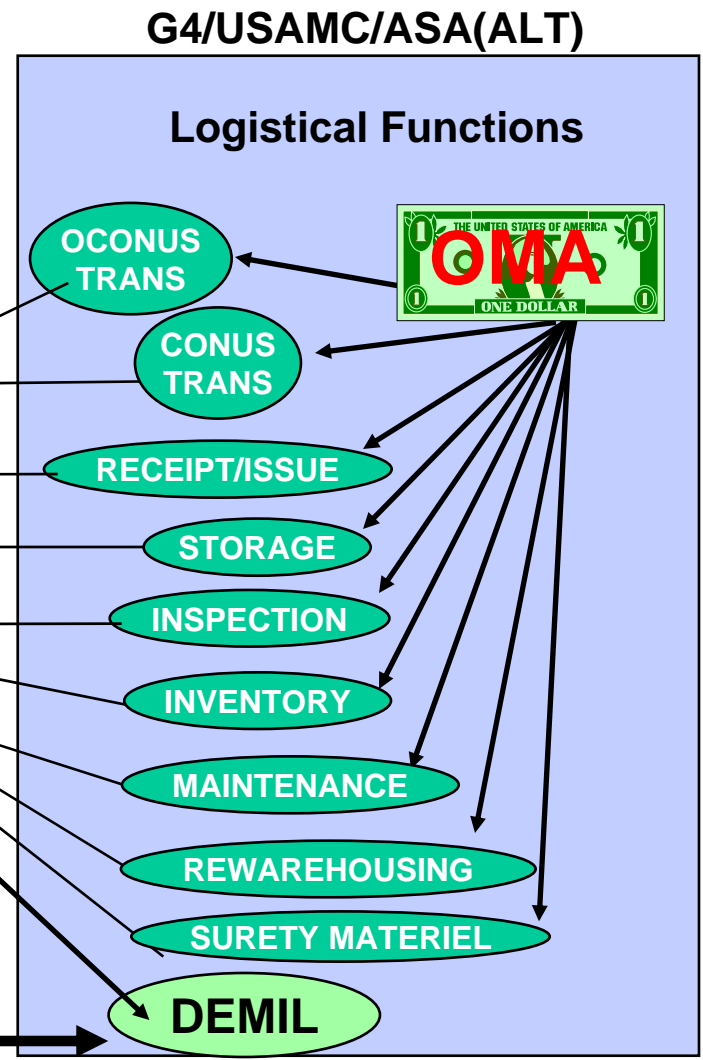
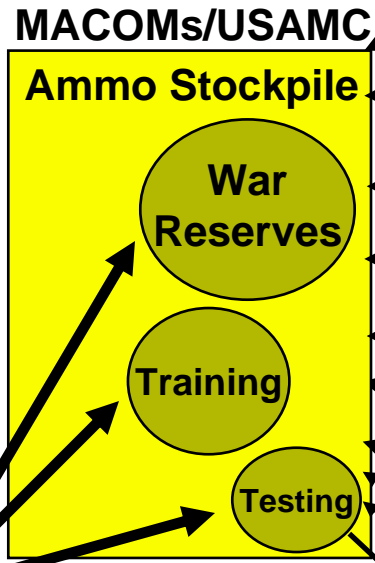
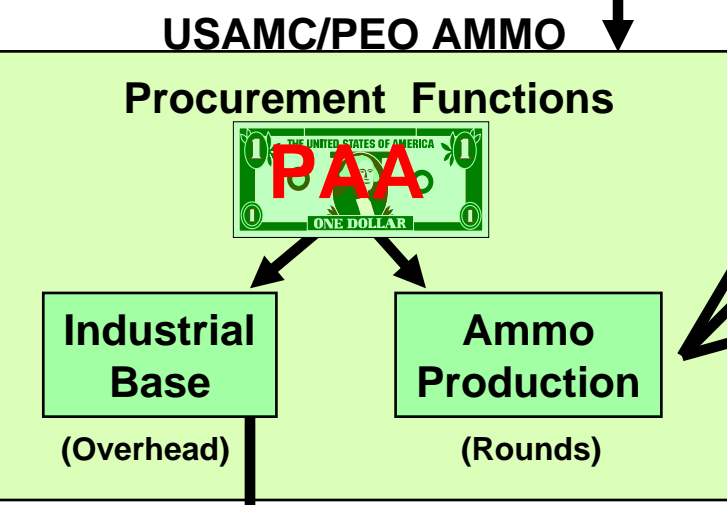
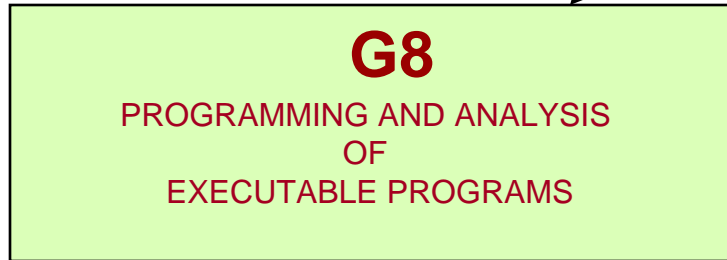
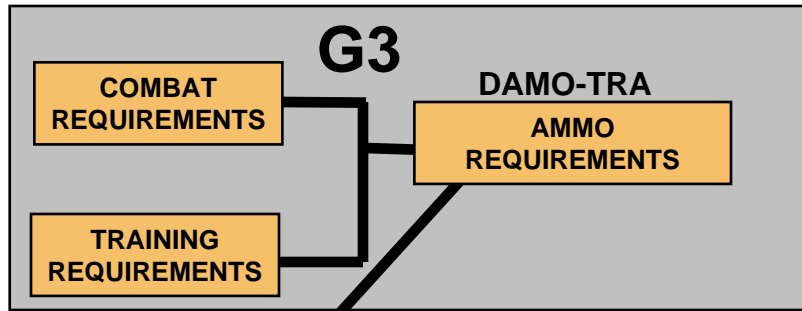



Ammunition Categories

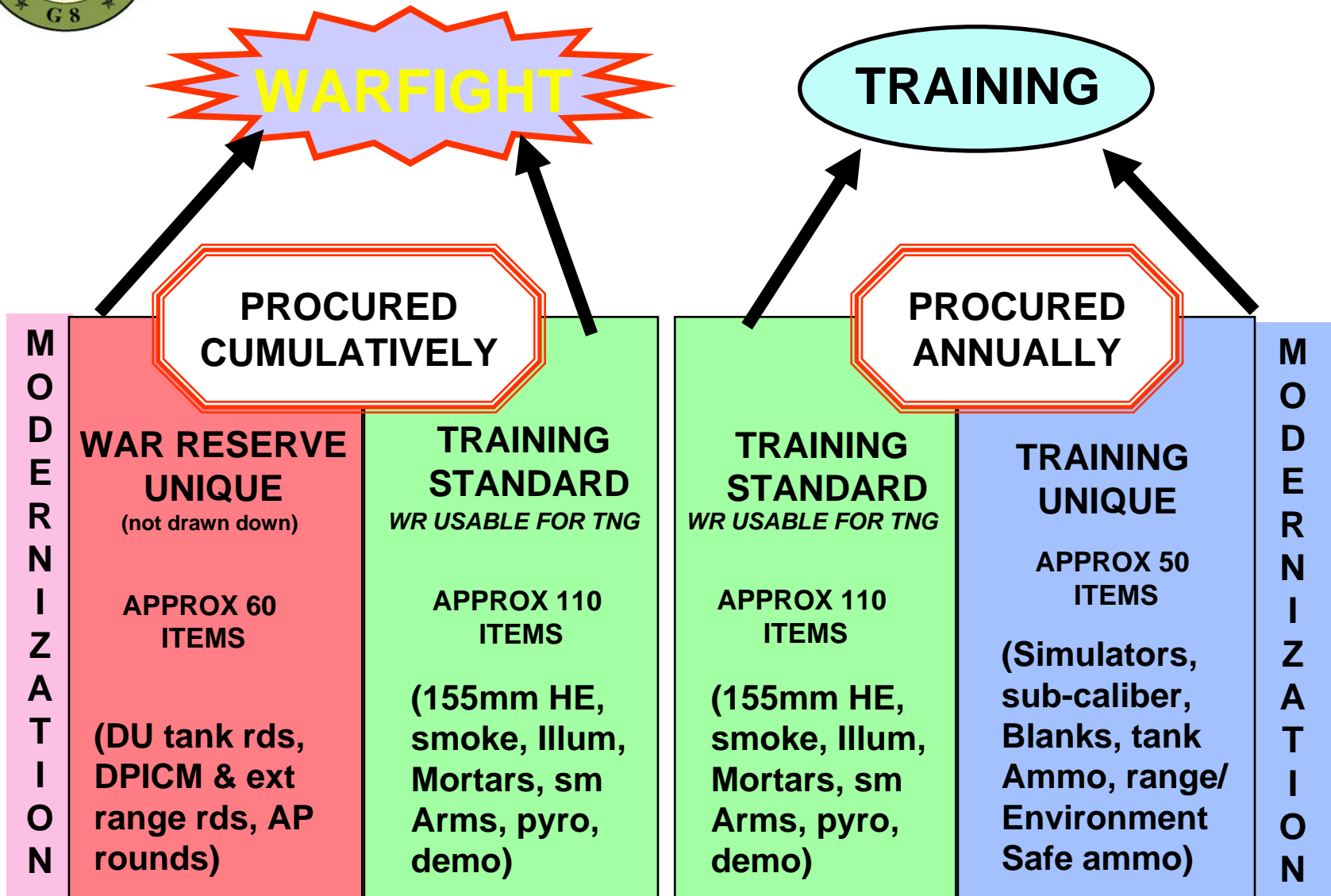



Total Ammunition (PAA) Picture

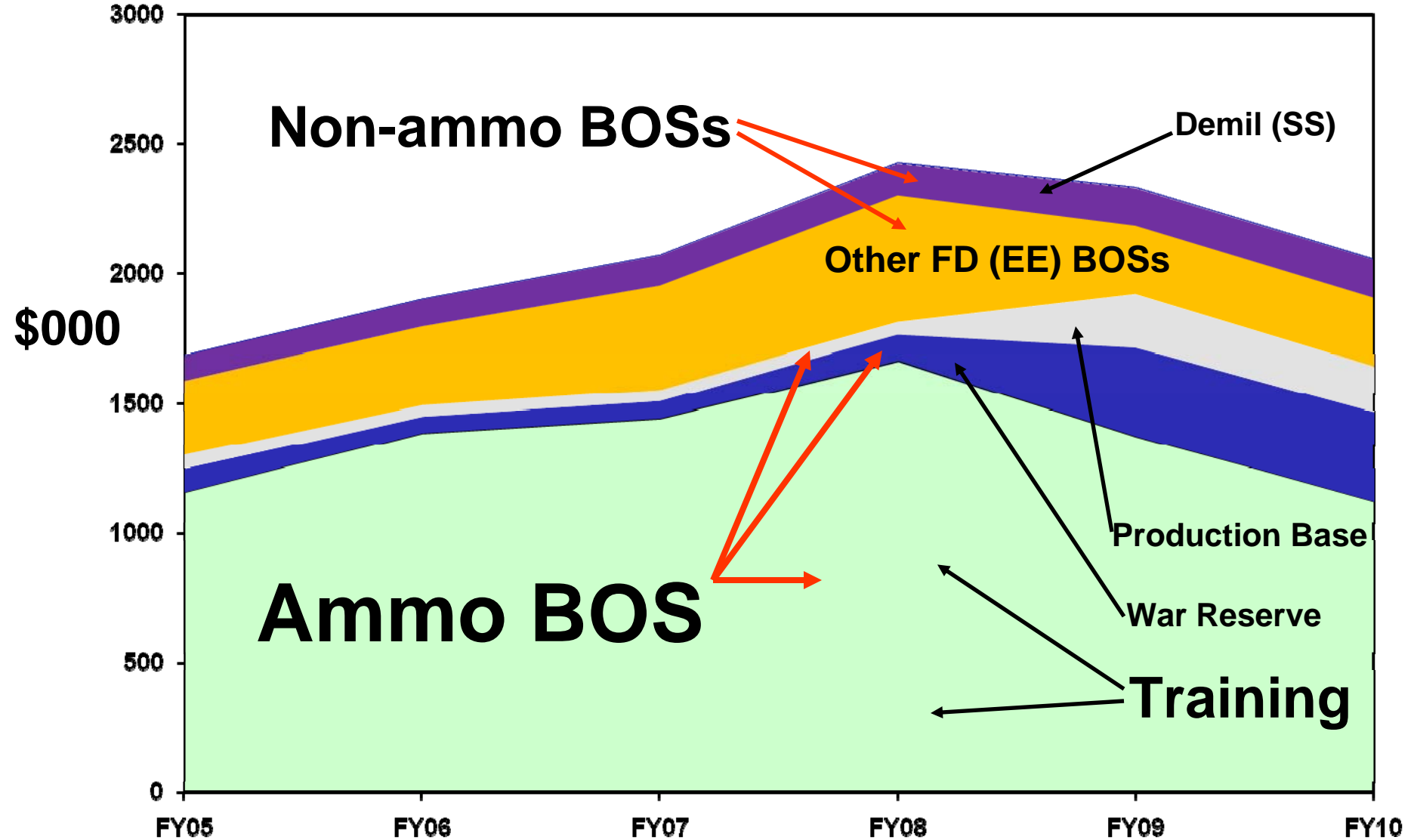



What is PAA?

(Procurement of Ammunition, Army)

Two Activities:

	<u>FY10</u>
• Activity 1 - Ammunition	\$1,732M
• Training/Test Ammo	\$1,125M - Ammo BOS
• War Reserve Fill	\$343M - Ammo BOS.
• Hydra Rockets Training Ammo	\$100M - Aviation BOS
• War Reserves/Modernization	\$164M - Other FD BOSs.
• Activity 2 - Prod Base Support	\$319M
• Industrial Facilities	\$170M - Ammo BOS.
• ARMS	\$3M - Ammo BOS.
• Demil	\$146M - SS PEG / G-4
• TOTAL	<hr/> \$2051M

Supplemental
\$371M



What is Ammo BOS?

Three Major Decision Packages (MDEPs)

		<u>FY 10\$\$</u>
1. RE01	TRAINING AMMO	\$1125M
2. RE06	WAR AND OPS AMMO	\$ 343M
3. RE04	PRODUCTION BASE	<u>\$ 173M</u>
	TOTAL	\$1641M

- Does not include non-Ammo BOS items (Hydra Rockets, Excaliber, M829A3, etc. in RE01 Or RE06, and does not include Demil in RE04)



AMMO FUNDING FY10 Base Budget

	Root	Request	Appropriated	Delta	Reason for Delta
BASE	AIRCRAFT LAUNCHED AMMO	96,572	94,572	-2,000	30mm Unjustified Program Growth
	AMMO PRODUCTION BASE	173,428	180,228	6,800	Projects at SCAAP and LCAAP
	AMMUNITION SUPPORT	43,608	49,928	6,320	Blue Grass equip and Supercritical Water Oxidation demil
	APL-A	56,387	56,387		
	ARTILLERY AMMO	183,942	180,142	-3,800	-5,000 105mm; -6,000 MACS; +7,200 155mm Illum
	AVIATION FLARES	75,242	63,242	-12,000	General reduction
	DEMIL	145,777	145,777		
	DEMOLITIONS	18,793	18,793		
	EXCALIBUR	62,292	62,292		
	GRENADES	49,910	49,910		
	HYDRA ROCKET	99,904	99,904		
	MEDIUM CALIBER AMMO	189,729	193,729	4,000	40mm all types
	MGS-STRYKER AMMO	7,741	7,741		
	MINES	815	815		
	MORTAR AMMO	157,287	164,687	7,400	60mm WP; 60mm Illum; 120mm Illum
	PGK	19,870	19,870		
	NON-LETHAL AMMO	7,378	7,378		
	PROTECTIVE SYSTEMS (IMS)	19,507	19,507		
	SHOULDER FIRED ROCKETS	45,302	42,802	-2,500	General reduction
	SIGNAL MUNITIONS	7,852	7,852		
SMALL CALIBER AMMO	452,816	452,816			
SPECIAL AMMUNITION	12,179	12,179			
TANK MAIN GUN AMMO	113,483	113,583			
SIMULATORS	12,081	12,081			
Grand Total		2,051,895	2,056,115	4,220	



AMMO FUNDING

FY09 Base Budget Request

	Root	Request	Appropriated	Delta	Reason for Delta
BASE	AIRCRAFT LAUNCHED AMMO	79,066	75,766	-3,300	30mm Unjustified Cost Growth
	AMMO PRODUCTION BASE	201,106	207,526	6,420	Projects at HSAAP, SCAAP, RFAAP, and Blue Grass
	AMMUNITION SUPPORT	41,449	41,449		
	APL-A	52,000	52,000		
	ARTILLERY AMMO	177,598	179,198	1,600	155mm all types
	AVIATION FLARES	68,376	68,376		
	DEMIL	143,901	143,901		
	DEMOLITIONS	28,886	32,086	3,200	Rapid Wall Breaching Kit (RWBK)
	EXCALIBUR	34,220	34,220		
	GRENADES	71,608	77,208	5,600	Thermite Grenades, Smoke Grenades
	HYDRA ROCKET	142,521	142,521		
	MEDIUM CALIBER AMMO	308,064	306,364	-1,700	25mm Unjustified Cost Growth
	MGS-STRYKER AMMO	7,662	7,662		
	MINES	7,452	7,452		
	MORTAR AMMO	193,177	201,577	8,400	Various Rounds, \$1.2M 105mm HEP
	PGK	15,633	15,633		
	NON-LETHAL AMMO	3,324	3,324		
	PROTECTIVE SYSTEMS	17,869	64,369	46,500	NLCS Bridge Supplemental
	SHOULDER FIRED ROCKETS	29,638	29,638		
	SIGNAL MUNITIONS	34,688	34,688		
SMALL CALIBER AMMO	444,782	436,169	-8,613	.50 cal all types, Unjustified Cost Growth	
SPECIAL AMMUNITION	6,843	6,843			
TANK MAIN GUN AMMO	125,151	125,151			
TANK-ABRAMS AMMO	34,031	34,031			
Grand Total		2,269,045	2,327,152	58,107	



Ongoing Budget Actions

- **FY11 Base Budget and Overseas Contingency Operations (OCO) Requests at Congress (last week – hopefully)**
- **Currently building FY12-17 POM and 12 OCO**
- **Incorporating changes based on SECDEF decisions on programs**
- **Quadrennial Defense Review underway**
- **Impacts of Cluster Munitions policy**
- **Army evaluating ARFORGEN impact to training**



Ammo Procurement Summary

Ammo Funding is a Balancing Act

- **Training**
 - Provide enough ammo for units to train
 - Buy enough ammo to replenish what is expended
- **War and Operations**
 - **SUSTAIN SOLDIERS IN CURRENT OPERATIONS**
 - Replenish stocks expended in operations
 - Build/Replenish War Reserve stocks
 - Modernize stocks in the process
- **Industrial Base**
 - Replace/Upgrade/Repair organic capabilities
 - Transition to efficiency upgrades
 - Ramp down production to avoid sharp changes