



NAVAL  
POSTGRDUATE  
SCHOOL



# Quantitative Comparison of Alternative Designs for a Joint C4I Capability Certification Management (JC3M) System

---

A Student Project

Gregory A. Miller  
Naval Postgraduate School  
Monterey, CA

Ian Finn  
Marine Corps Tactical  
Systems Support Activity  
Camp Pendleton, CA

# Outline

---



- Introduction & motivation
- A tailored SE process
- Problem refinement
- Design Alternatives
- Modeling & Simulation
- Life Cycle Cost Estimates
- Analysis of Alternatives
- Conclusions and further study

# Motivation: Acquisition system & SoS integration needs

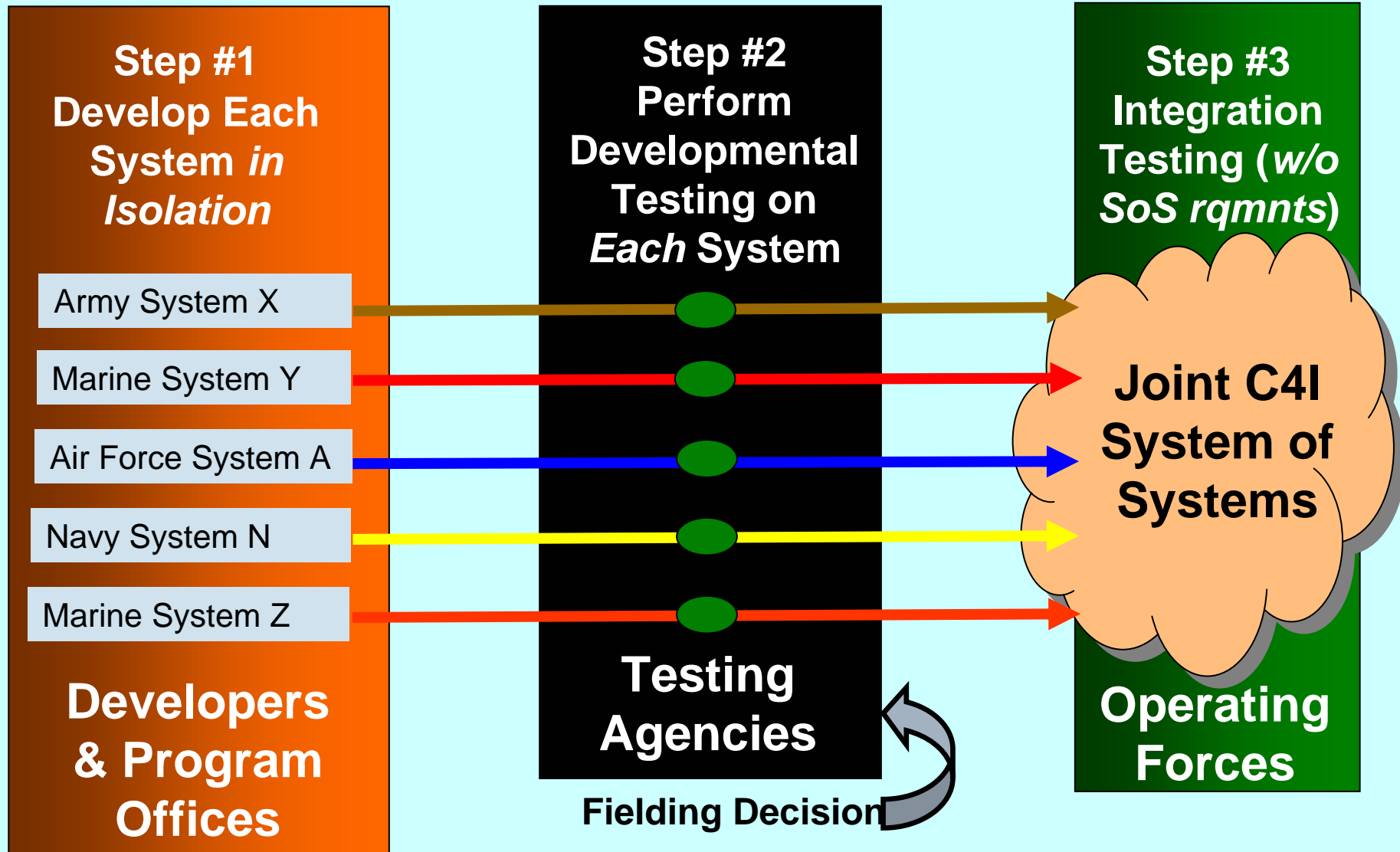

# Current SoS Testing and Fielding

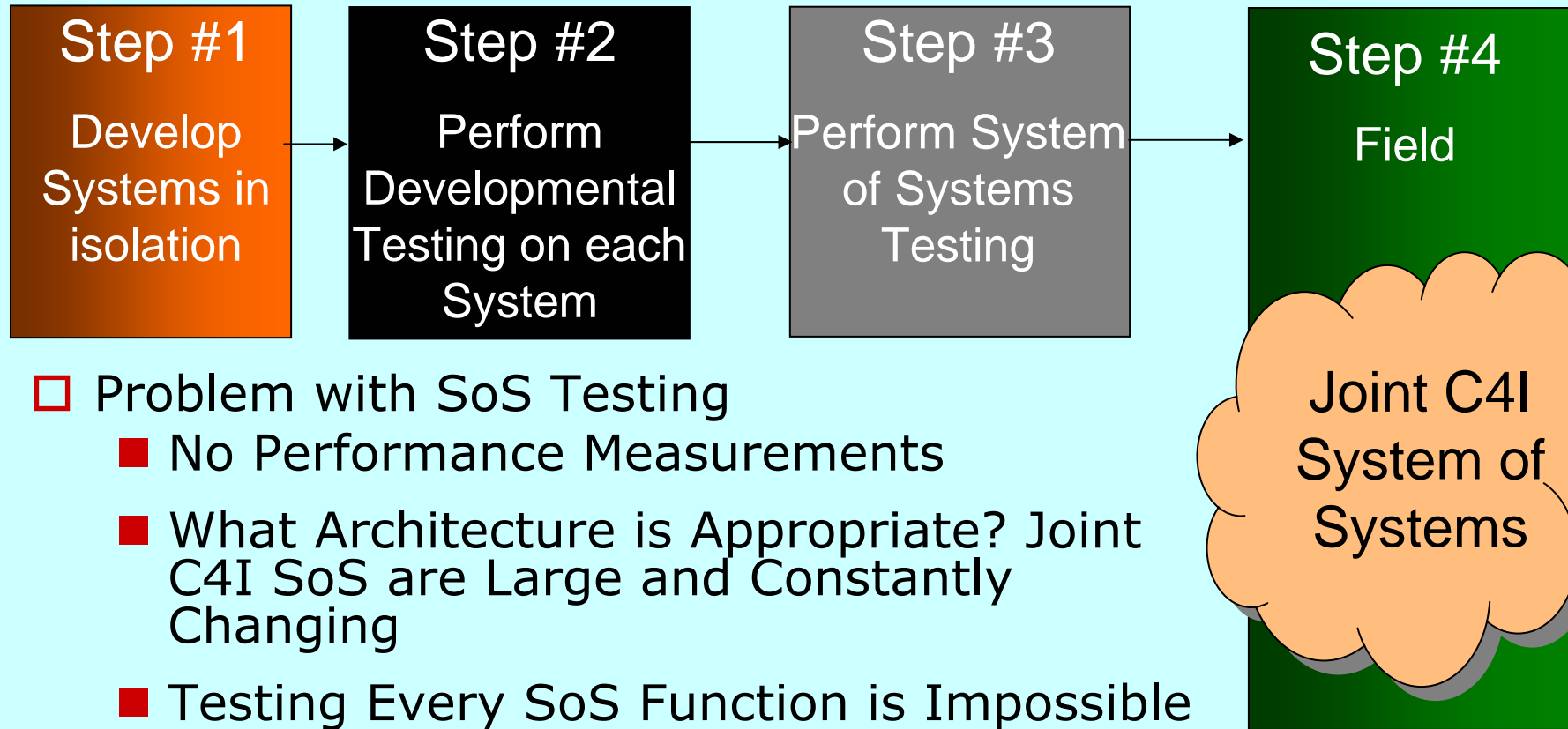

## ❑ Problem with SoS Testing

- No Performance Measurements
- What Architecture is Appropriate? Joint C4I SoS are Large and Constantly Changing
- Testing Every SoS Function is Impossible
- Hard to Determine What Failure is Since Quality of Service Requirements Change

# What is the Real Problem?



Is it That DoD Does Not Define Performance Measures for Joint C4I SoS?

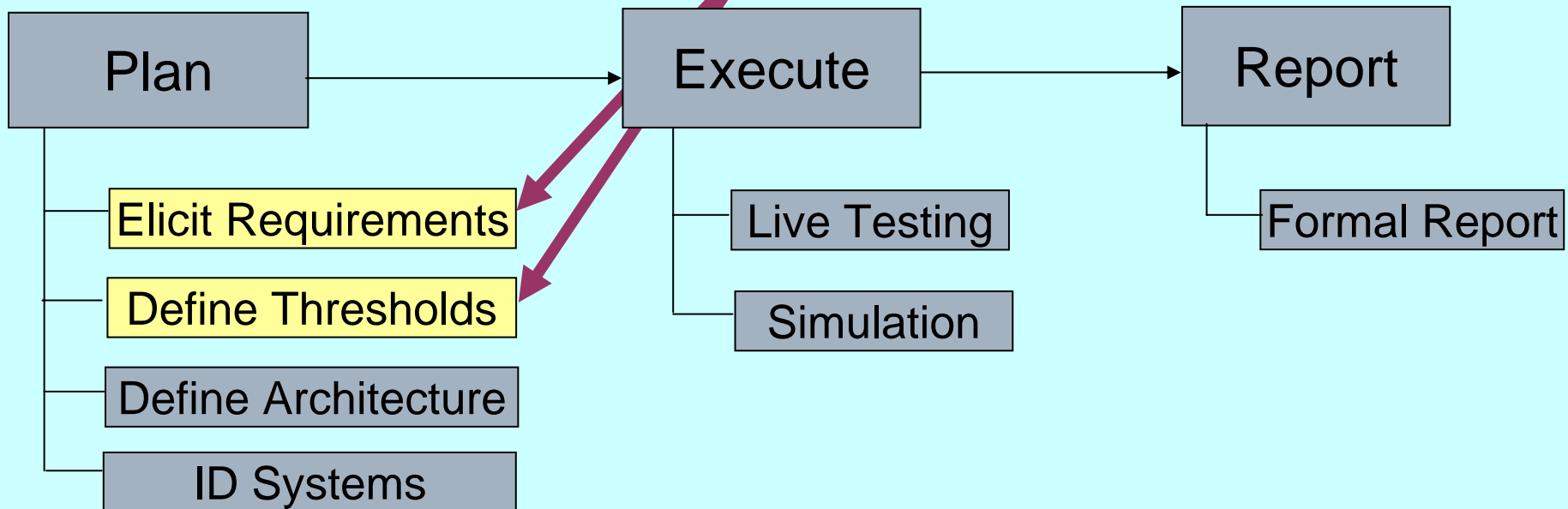

# What's the Solution?



Develop a System that articulates SoS capabilities, determines whether each SoS component system supports these capabilities, and reports the results

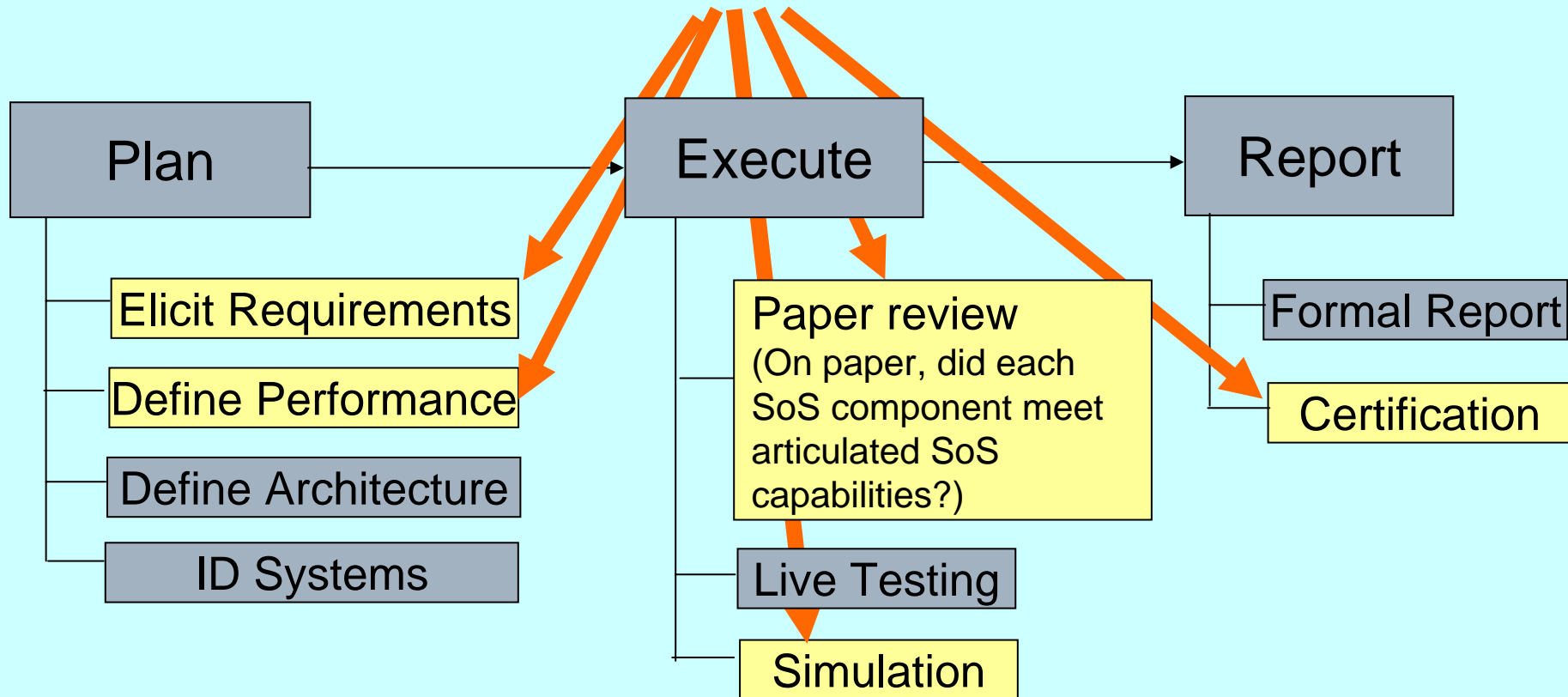

# JC3M in Testing and Fielding

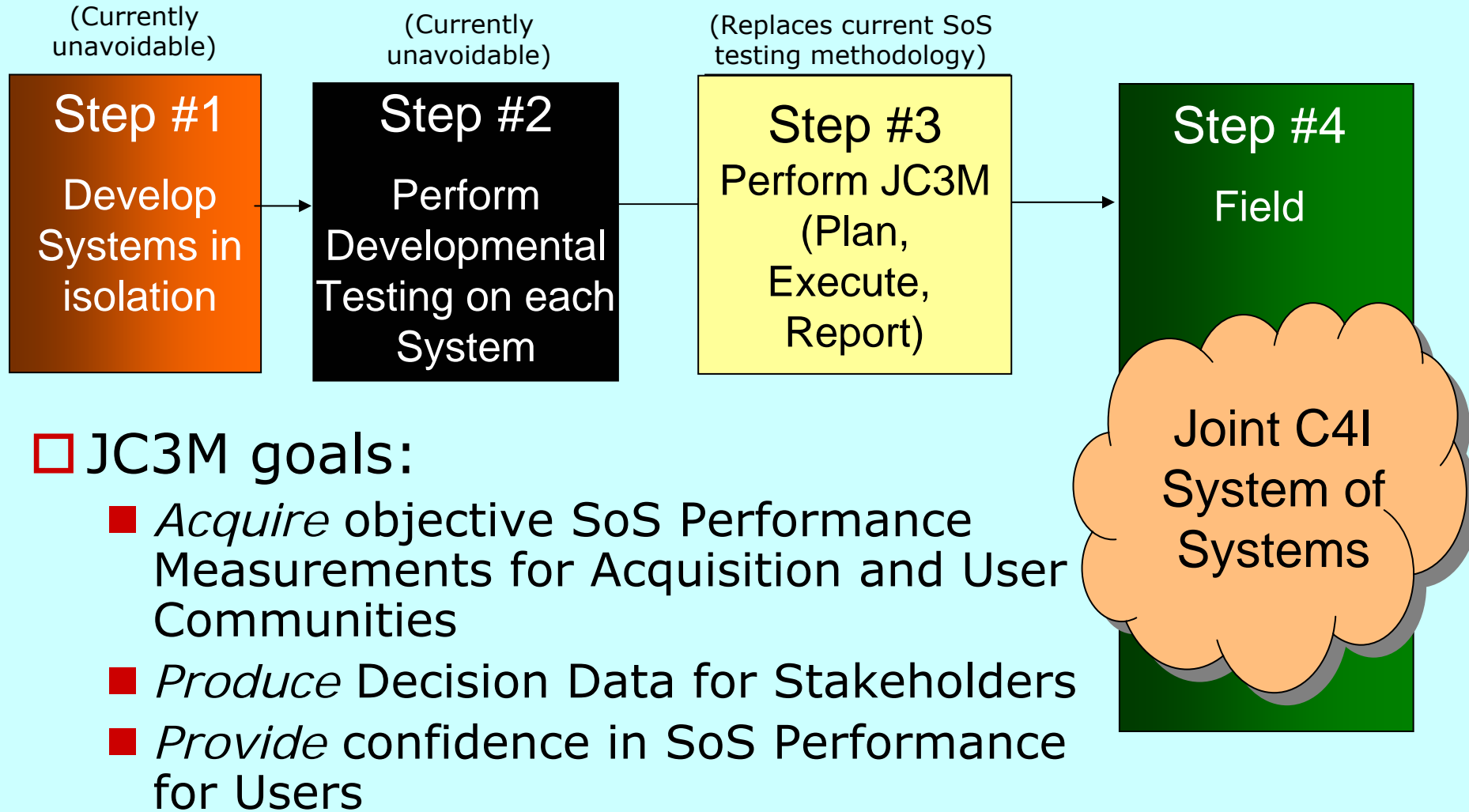

# Systems Engineering Process

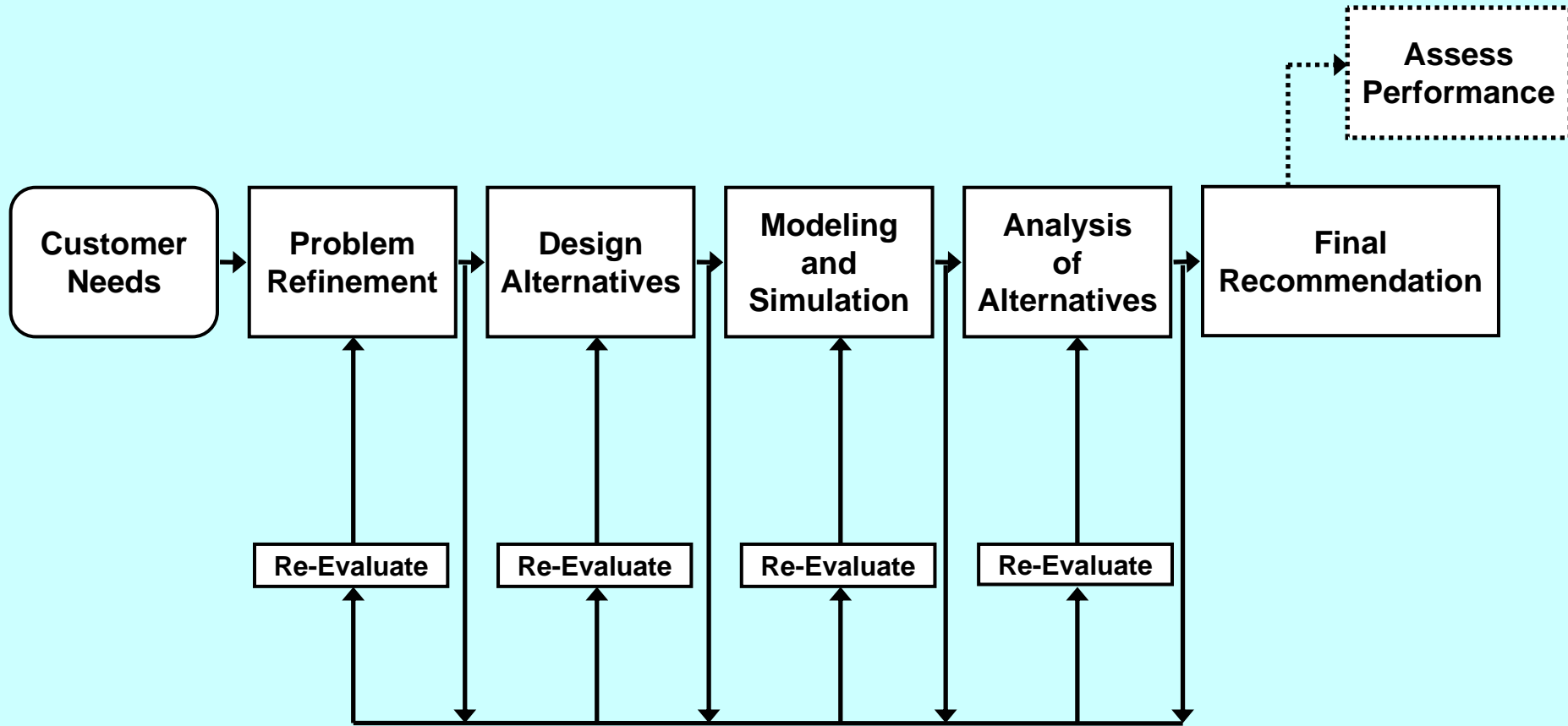



# Revised Problem Statement



- Original problem focus:
  - Define Threshold Values

- Research revealed the true problem ...

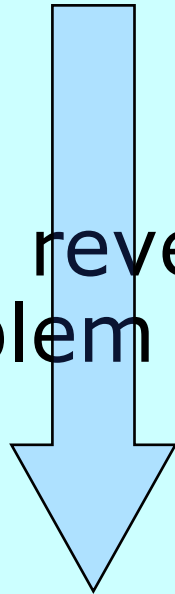

- Refined problem focus:
  - Define Measures to be Evaluated

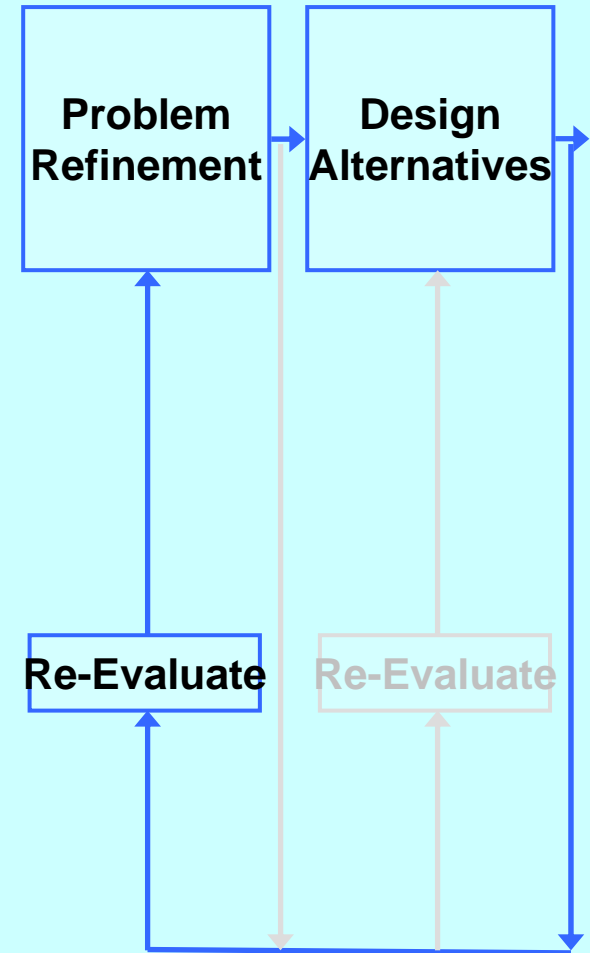

# Revised Problem



Define Performance Measures for Joint C4I SoS

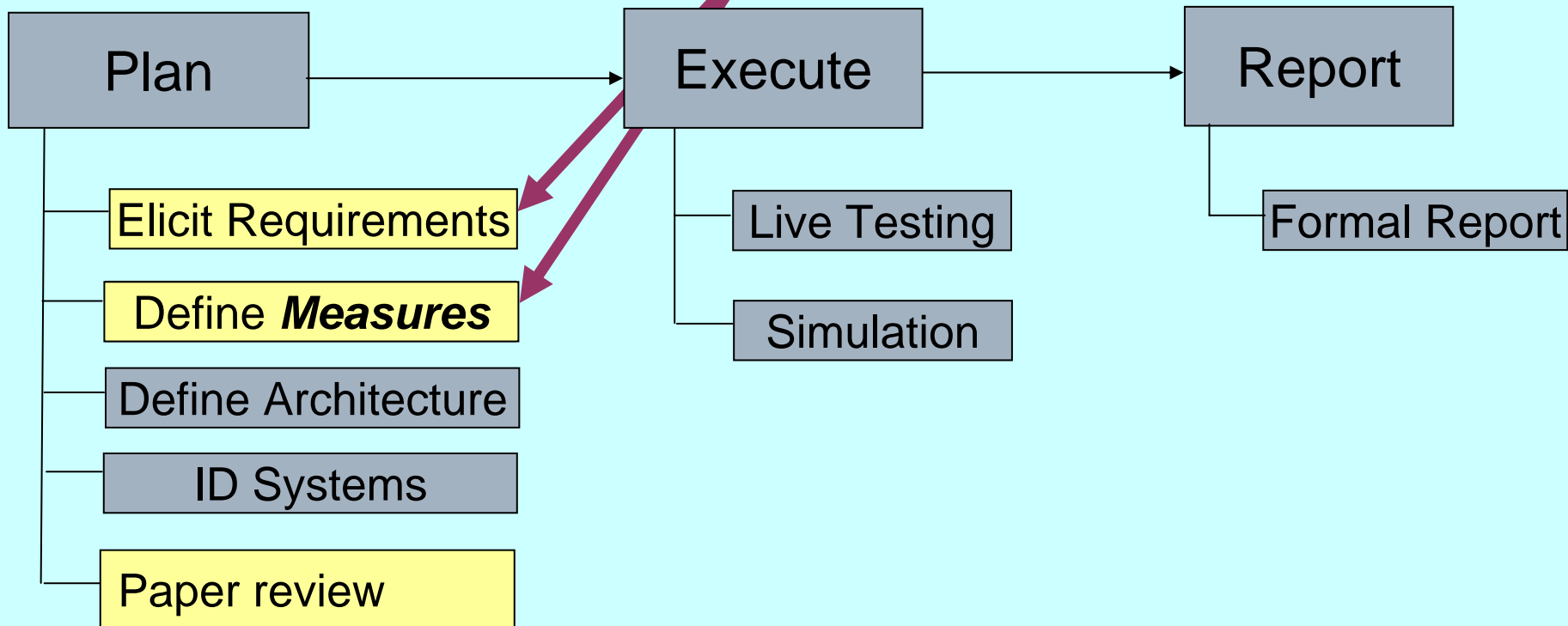

# JC3M Value Hierarchy



- ❑ Developed from Refined Problem Statement
- ❑ Based on Stakeholder Analysis

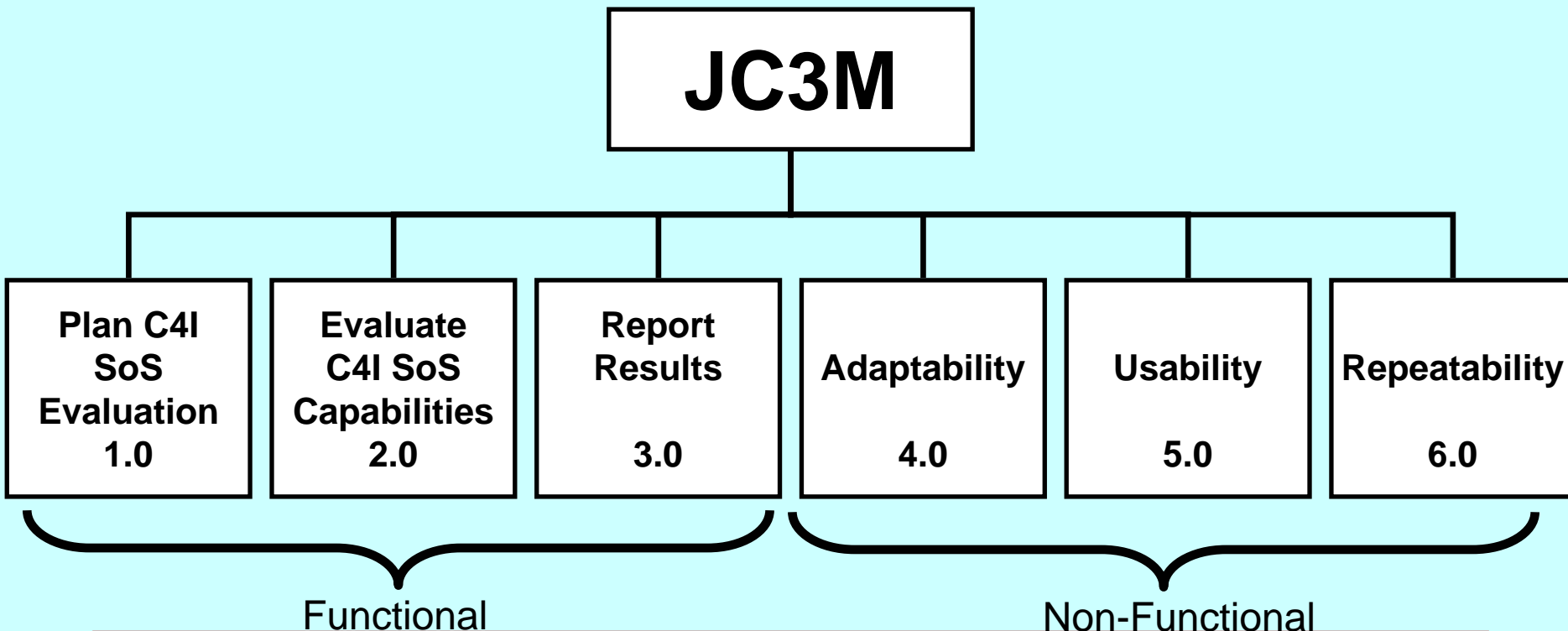



## JC3M Functional Decomposition

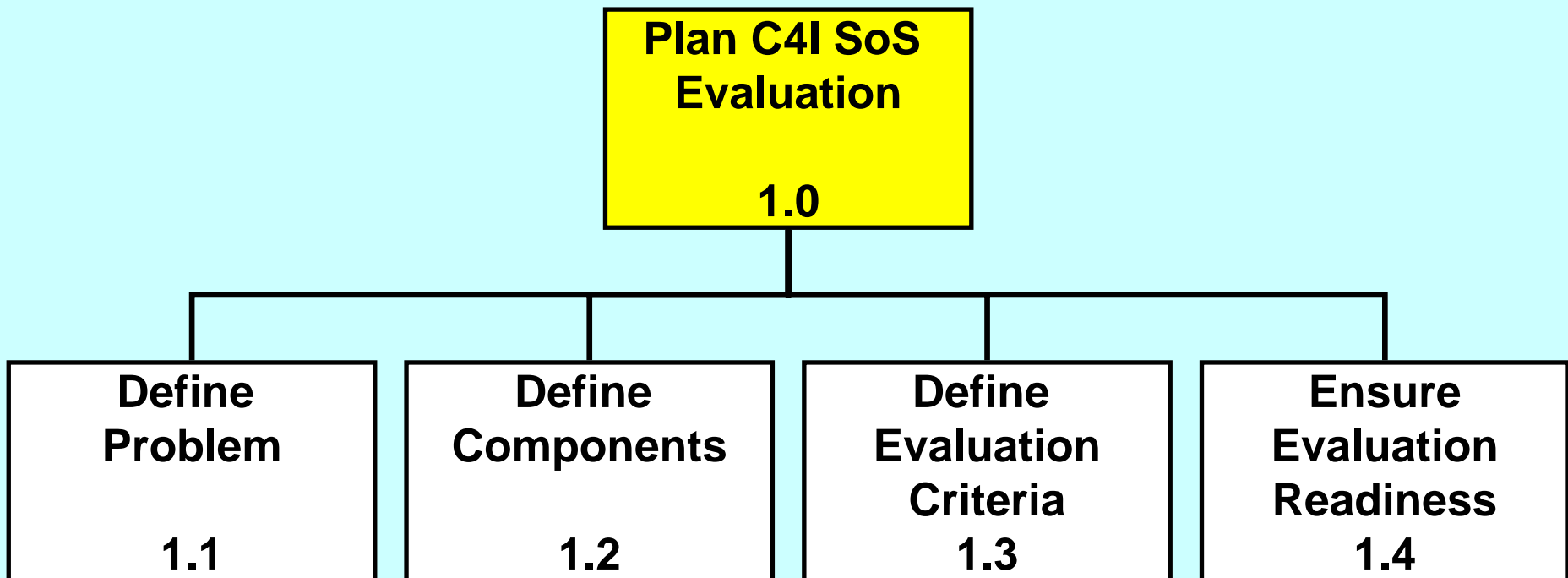

# Define Evaluation Criteria 1.3

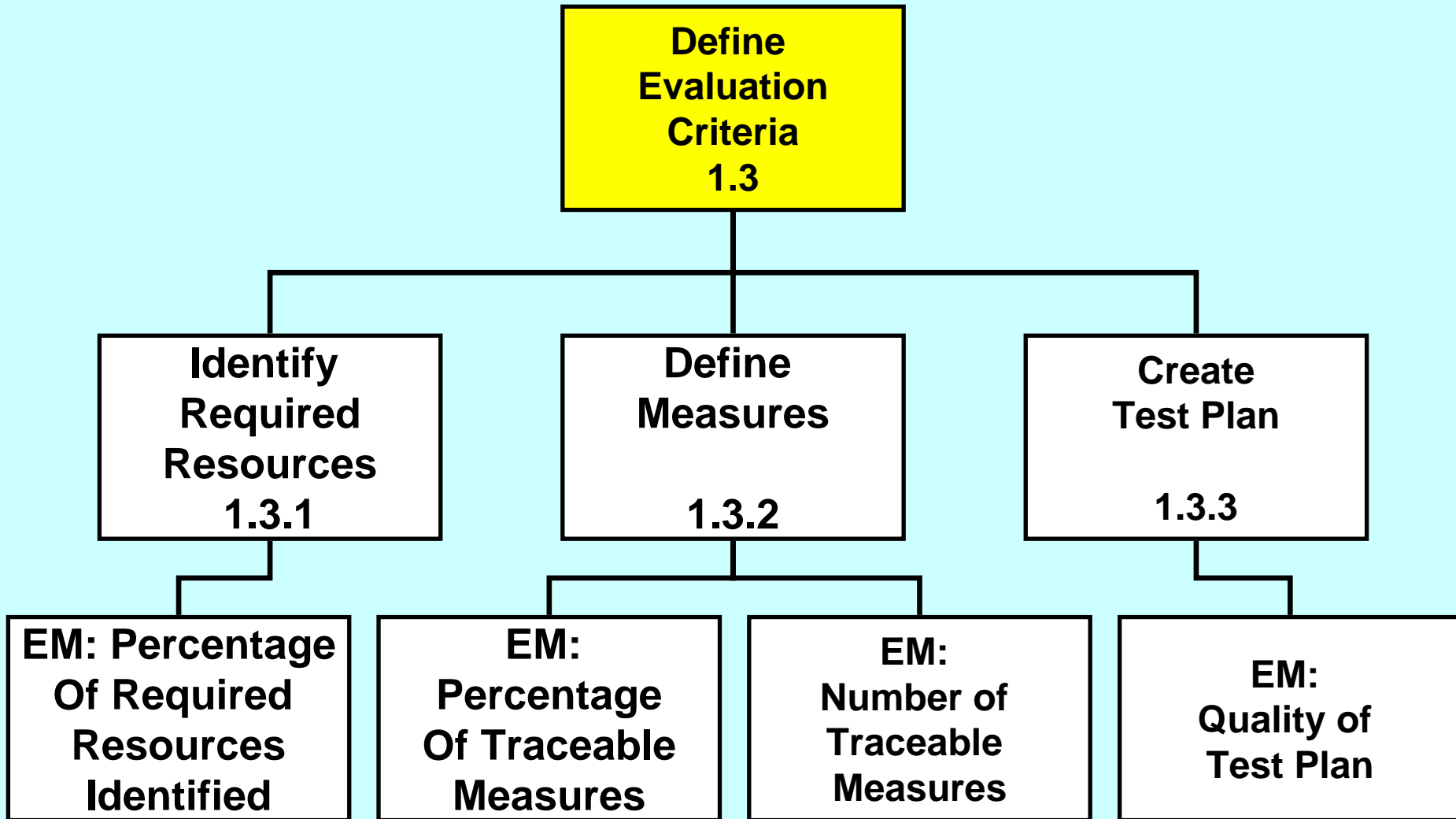

# JC3M Value Hierarchy

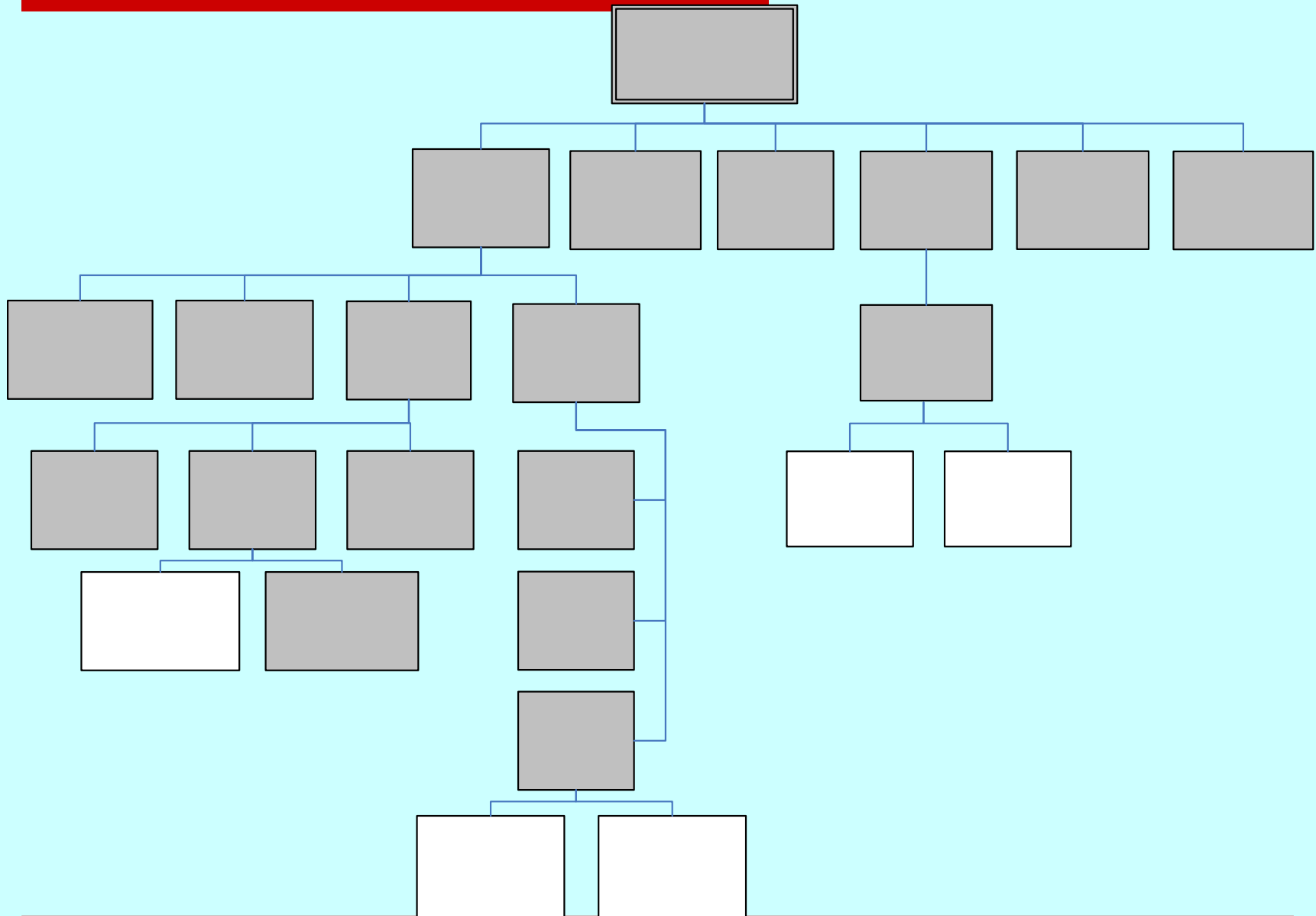

# Evaluation Measures

	Percentage of Traceable Measures	Days to Plan Evaluation	Quality of Planning Outputs	Elasticity of Labor	Elasticity of Duration
<b>JC3M Function</b>	Define Measures 1.3.2	Planning Results 1.4.3	Planning Results 1.4.3	Input System Flexibility 4.1	Input System Flexibility 4.1
Definition	<p>Alternative generated measures, traceable to stakeholder requirements, divided by the number of measures generated by the alternative.</p> <p>Ratio level data, from 0 – 100%</p>	<p>Elapsed time (in days) of planning for C4I SoS evaluation</p> <p>Ratio level data <math>\geq 0</math> hours</p>	<p>Quantify the overall quality of the planning documents produced.</p> <p>Ordinal – Low, Medium, High</p>	<p>Divide percent change in labor hours to conduct planning phase of JC3M by the percent change in systems under test. (Quantifies ability to scale.)</p> <p>Ratio level data from 0 – <math>\infty</math></p>	<p>Divide percent change in duration to conduct planning phase of JC3M by the percent change in systems under test. (Quantifies ability to scale.)</p> <p>Ratio level data from 0 – <math>\infty</math></p>
Rationale and Relevance	<p>Identifies objectivity of performance measures.</p> <p>Performance measures traceable to doctrinal references will be perceived as objective, increasing the value of the evaluation.</p>	<p>Predicts SoS evaluations that can be conducted in a year.</p> <p>Alternatives that permit multiple SoS evaluations generate data to support fielding decisions sooner.</p>	<p>Identifies predicted utility of alternative.</p> <p>Quality of the planning products drives the overall value of the alternative.</p>	<p>Predicts changes in cost of SoS evaluation based on size.</p> <p>Can be used to determine most effective alternative based on SoS size.</p>	<p>Predicts changes in duration of SoS evaluation based on size.</p> <p>Can be used to determine most effective alternative based on SoS size.</p>

# Alternatives

---



FEDOS

MC3T

JTEM -CTM

Alternative #1

Alternative #2



# Morphological Box Process



Define the Problem	ID Systems Under Test	Define Criteria	Ensure Readiness
Have SMEs Do It	What PM Requests	Ask Users	PM Review
Acquisition Manager Defines	DoDAF Document Review	What PM Asks For	SAR Review
Acquisition Manager Defines	Engineering Document Review	Test Everything	Test Manager Review
Get from CDD	Ask JITC	Stakeholder Review	

# Alternative #1



## "System Capabilities Review (SCR)"

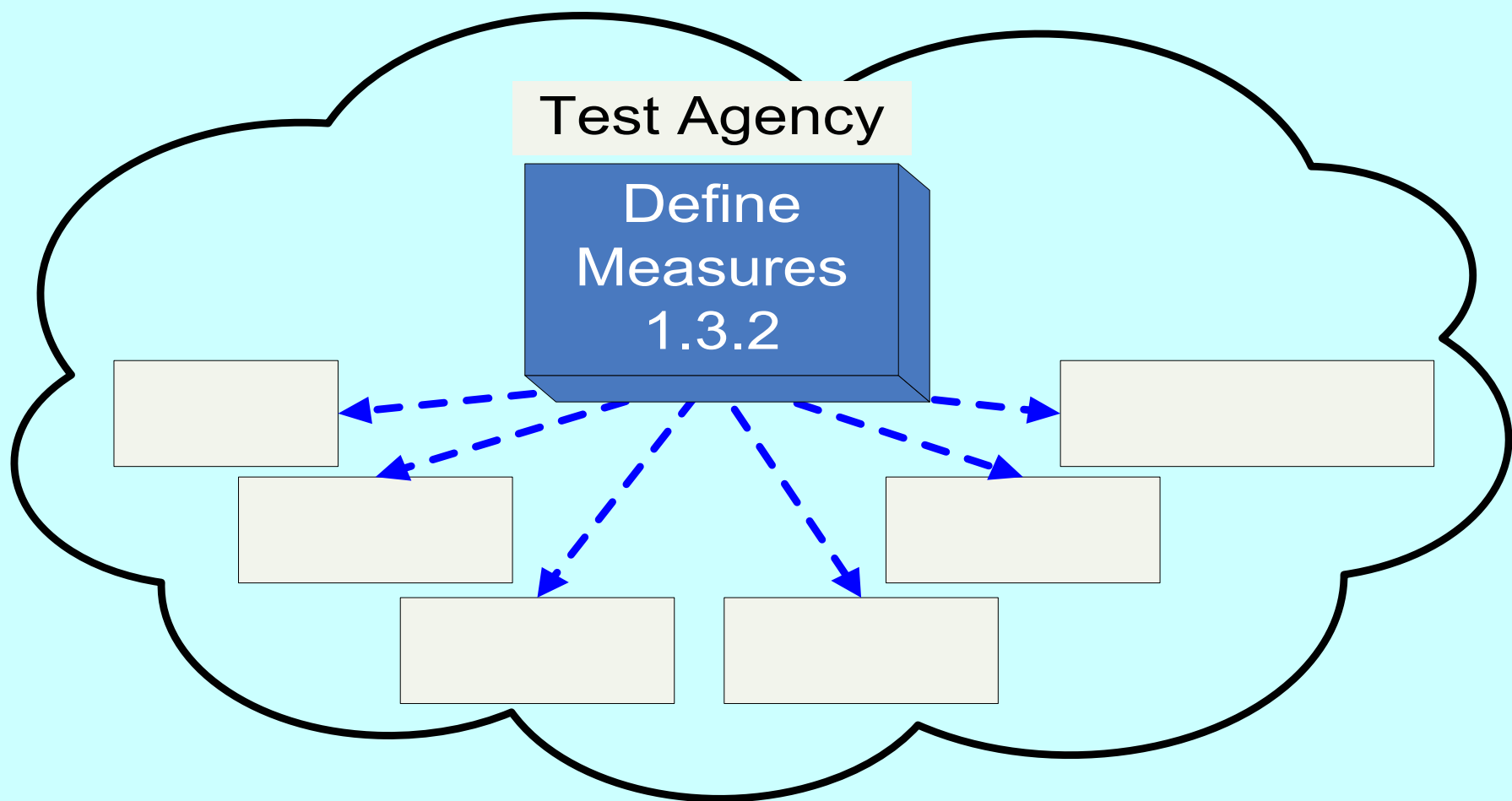

# Alternative #2



“Functional Capability Board (FCB)”

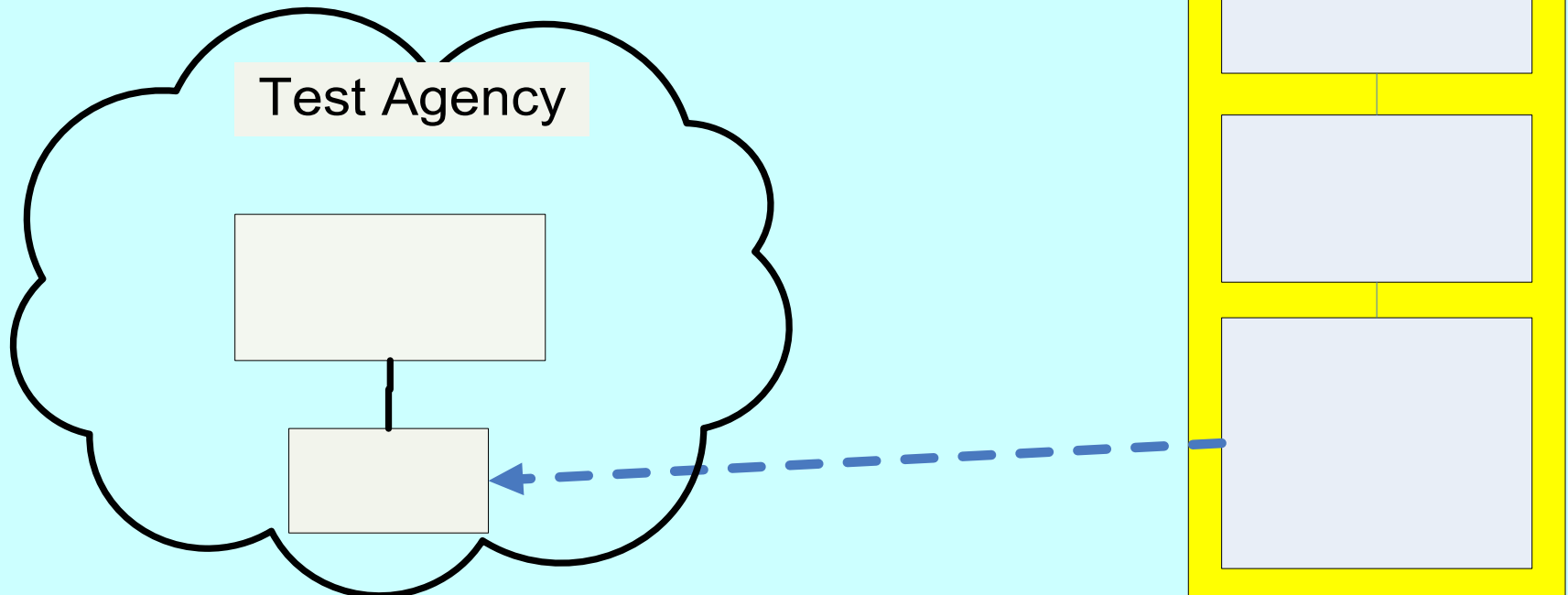

# Differences

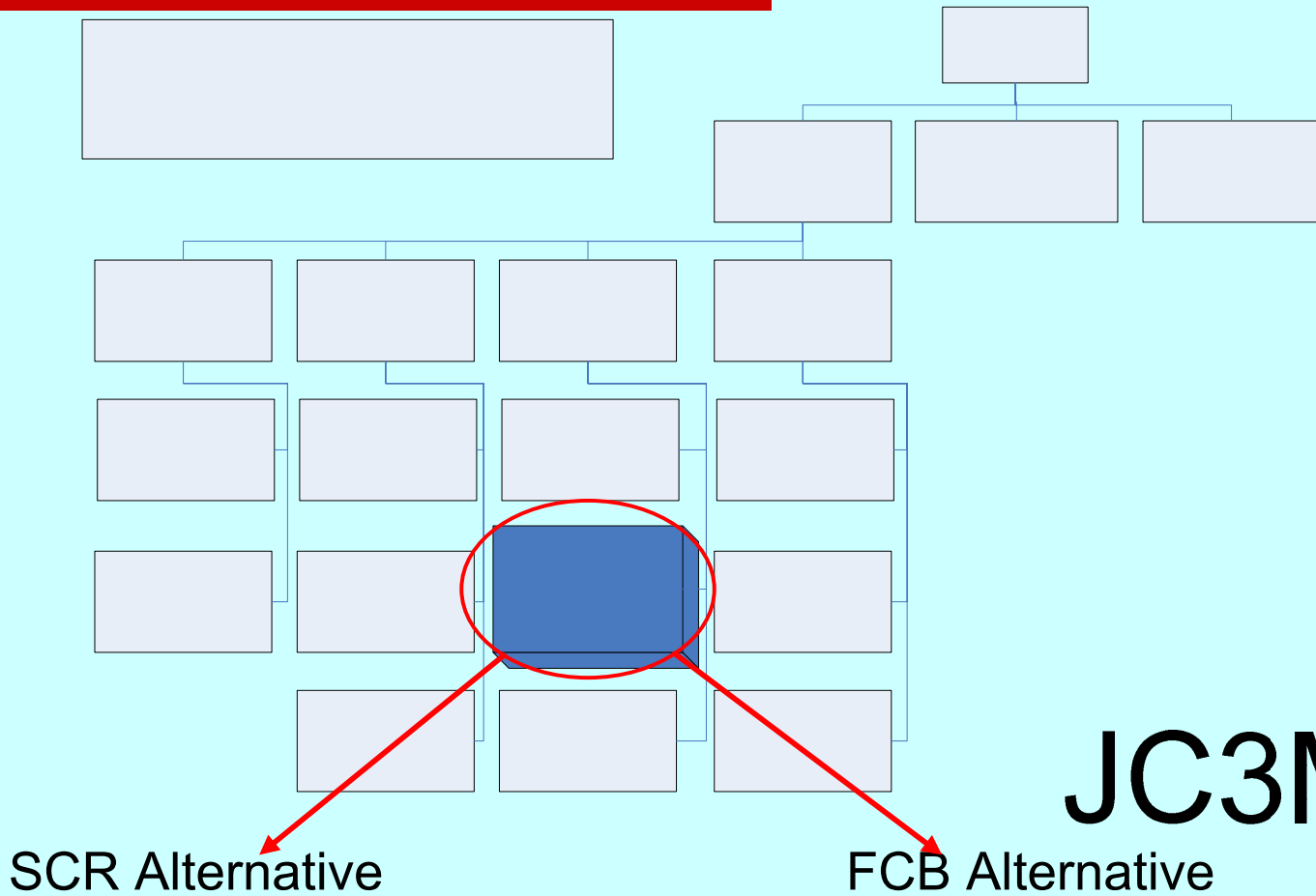

# Alternatives Summary



	Personnel	Use	Scope	Measures
<b>FEDOS</b>	Internal	Past	Service <b><u>test</u></b>	<b><u>Stakeholder agreement</u></b>
<b>MC3T</b>	Internal + External	Proof of concept	Service system <b><u>certification</u></b>	Doctrine developers & stakeholders
<b>JTEM CTM</b>	Internal	Model	Joint <b><u>Mission Effectiveness</u></b> Assessment	Doctrine, System documentation
<b>SCR</b>	Internal	Proposed	<b><u>Joint</u></b> capability assessment	Doctrine, System documentation
<b>FCB</b>	Internal + External	Proposed	<b><u>Joint</u></b> capability assessment	<b><u>C4I SME panel</u></b>

# Fill in the blanks!



	Percentage of Traceable Measures	Days to Plan Evaluation	Quality of Planning Outputs	Elasticity of Labor	Elasticity of Duration
Alternatives	<b>EM #1: 1.3.2</b>	<b>EM #2: 1.4.3</b>	<b>EM #3: 1.4.3</b>	<b>EM #4: 4.1</b>	<b>EM #5: 4.1</b>
FEDOS					
MC3T					
JTEM - CTM					
FCB					
SCR	Offline Evaluation	POW-ER	Offline Evaluation	Arena	

# M&S Overview

---

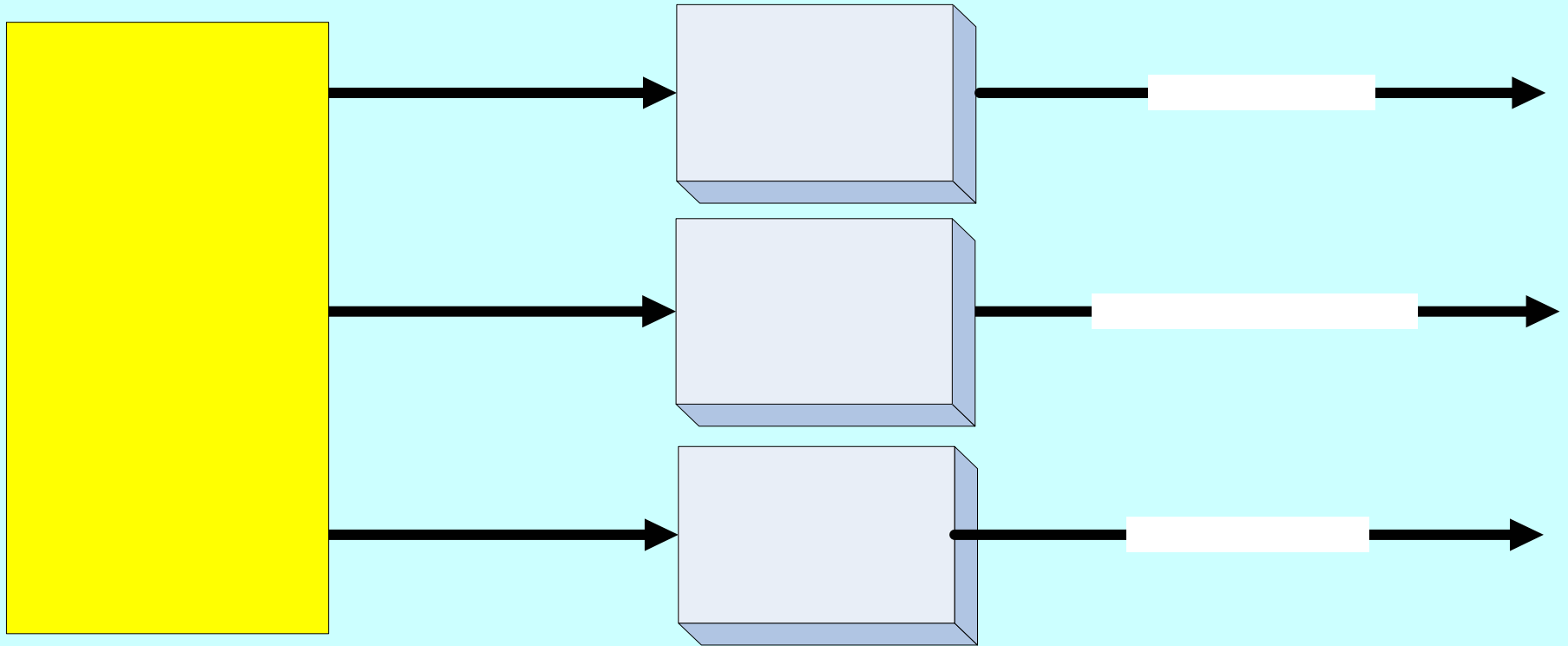

Input

# M&S Results



	Percentage of Traceable Measures	Days to Plan Evaluation	Quality of Planning Outputs	Elasticity of Labor	Elasticity of Duration
<b>Alternatives</b>	<b>1.3.2</b>	<b>1.4.3</b>	<b>1.4.3</b>	<b>4.1</b>	<b>4.1</b>
FEDOS		140 days		0.87	0.86
MC3T		121 days		0.78	0.78
JTEM CTM		73 days		1.04	0.83
FCB		158 days		0.97	0.97
SCR		127 days		0.71	0.71



# Complete EM



	Percentage Traceable Measures %	Days to Plan Evaluation Days	Planning Output Quality Likert Scale 1-4	Labor Elasticity Unitless	Duration Elasticity Unitless
<b>Ideal Value</b>	<b>100%</b>	<b>Less is better</b>	<b>4 is Ideal</b>	<b>Less is better</b>	<b>Less is better</b>
FEDOS	0	140	3.17	0.87	0.87
MC3T	72	121	3.25	0.78	0.78
JTEM CTM	<b>92</b>	<b>73</b>	<b>3.42</b>	1.04	0.83
SCR	<b>92</b>	158	3.00	0.98	0.98
FCB	88	127	2.75	<b>0.72</b>	<b>0.72</b>

# LCCE – Cost Breakdown Structure

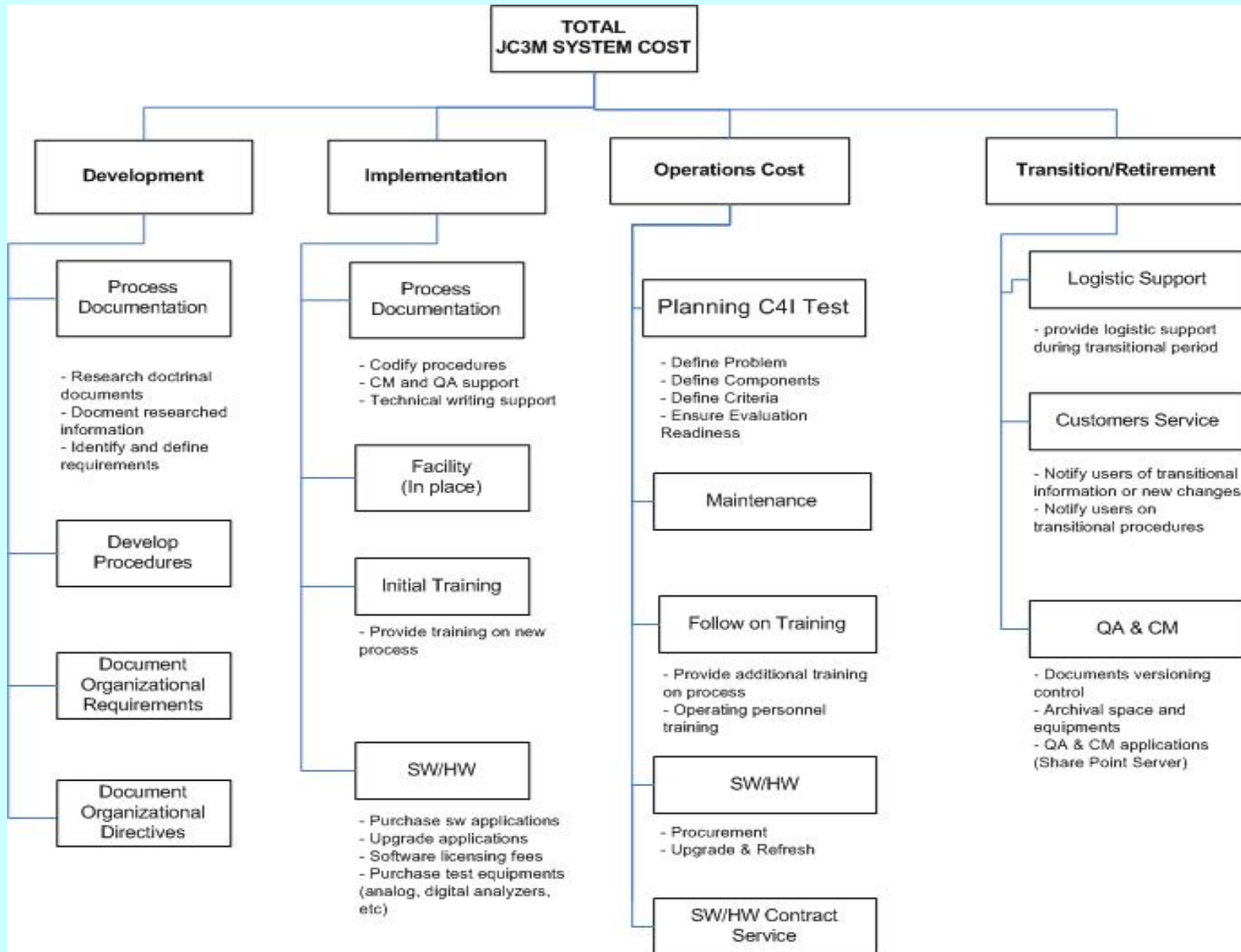

# Life Cycle Phases of JC3M

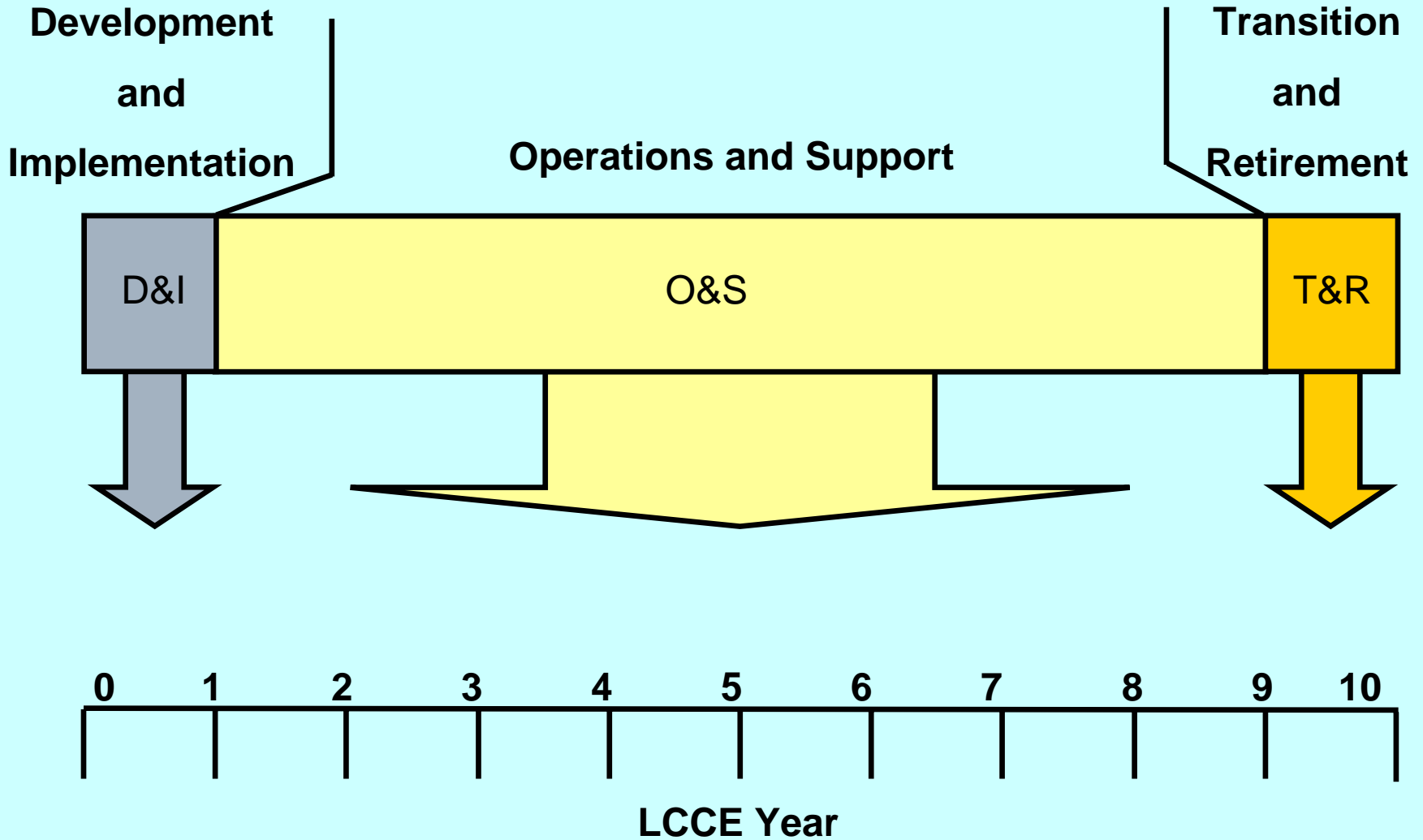

# LCCE – Cost Summary



Alternatives	Life-Cycle Year					Total Cost (\$)
	1	2	3	4...9	10	
FEDOS	1,052,527	419,497	419,497	419,497	52,200	<b>5,010,706</b>
MC3T	1,169,414	525,537	525,537	525,537	52,200	<b>5,975,913</b>
JTEM-CTM	1,030,000	2,470,000	1,169,414	558,535	52,200	<b>6,972,824</b>
FCB	2,323,117	650,223	650,223	650,223	52,200	<b>8,127,101</b>
SCR	2,121,421	624,451	624,451	624,451	52,200	<b>7,719,232</b>

Interpretation: The delta between the highest and lowest LCCE  $\approx$  \$3M, which is not a significant sum over a ten year span.

# Value Modeling Overview



	Percentage of Traceable Measures (%)	Days to Plan Evaluation (Days)	Quality of Planning Outputs	Elasticity of Labor	Elasticity of Duration
<b>Ideal Value</b>	100%	Less is better			
FEDOS	0	140			
MC3T	72	121			
JTEM CTM	92	73			
SCR	88	127			
FCB	92	158			

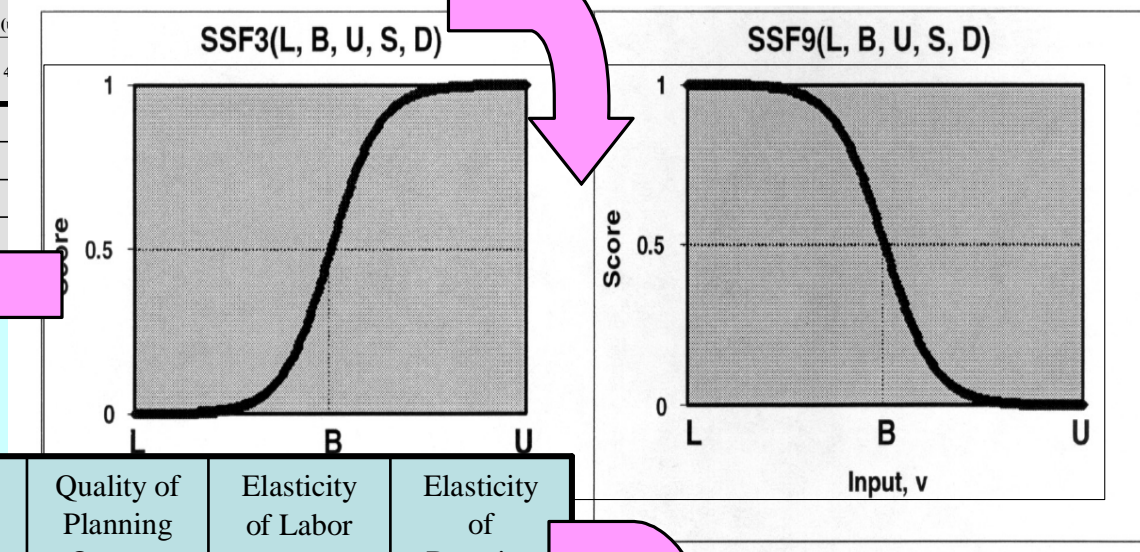

EM Weights	Percentage of Traceable Measures	Days to Plan Evaluation	Quality of Planning Outputs	Elasticity of Labor	Elasticity of Duration	Quality of Planning Outputs	Elasticity of Labor	Elasticity of Duration	Overall Utility (0-1)
	0.248	0.058							
FEDOS	0.00	0.04	0.39	0.06	0.14				0.63
MC3T	0.02	0.05	0.39	0.07	0.16				0.71
JTEM CTM	0.24	0.06	0.40	0.04	0.15				0.89
SCR	0.24	0.02	0.37	0.05	0.10				0.79
FCB	0.22	0.05	0.34	0.08	0.18				0.87

Translation of raw measurements into a normalized set of weighted values that can be added.

# Quantitative Modeling Matrix



	Percentage Traceable Measures	Evaluation Planning Duration	Planning Output Quality	Labor Elasticity	Duration Elasticity	Overall Utility (0 – 1)
<b>FEDOS</b>	0.00	0.04	0.39	0.06	0.14	<b>0.63</b>
<b>MC3T</b>	0.02	0.05	0.39	0.07	0.17	<b>0.71</b>
<b>JTEM CTM</b>	<b>0.24</b>	<b>0.06</b>	<b>0.40</b>	0.04	0.15	<b>0.89</b>
<b>SCR</b>	<b>0.24</b>	0.02	0.37	0.05	0.10	<b>0.79</b>
<b>FCB</b>	0.22	0.05	0.34	<b>0.08</b>	<b>0.18</b>	<b>0.87</b>

# Utility & LCCE



	Percentage of Traceable Measures	Days to Plan Evaluation	Quality of Planning Outputs	Elasticity of Labor	Elasticity of Duration	Overall Utility (0 – 1)	LCCE (\$ M)
FEDOS	0.00	0.04	0.39	0.06	0.14	0.63	5.01
MC3T	0.02	0.05	0.39	0.07	0.17	0.71	5.98
JTEM CTM	0.24	0.06	0.40	0.04	0.15	0.89	6.97
SCR	0.24	0.02	0.37	0.05	0.10	0.79	7.72
FCB	0.22	0.05	0.34	0.08	0.18	0.87	8.13

# LCCE vs Utility

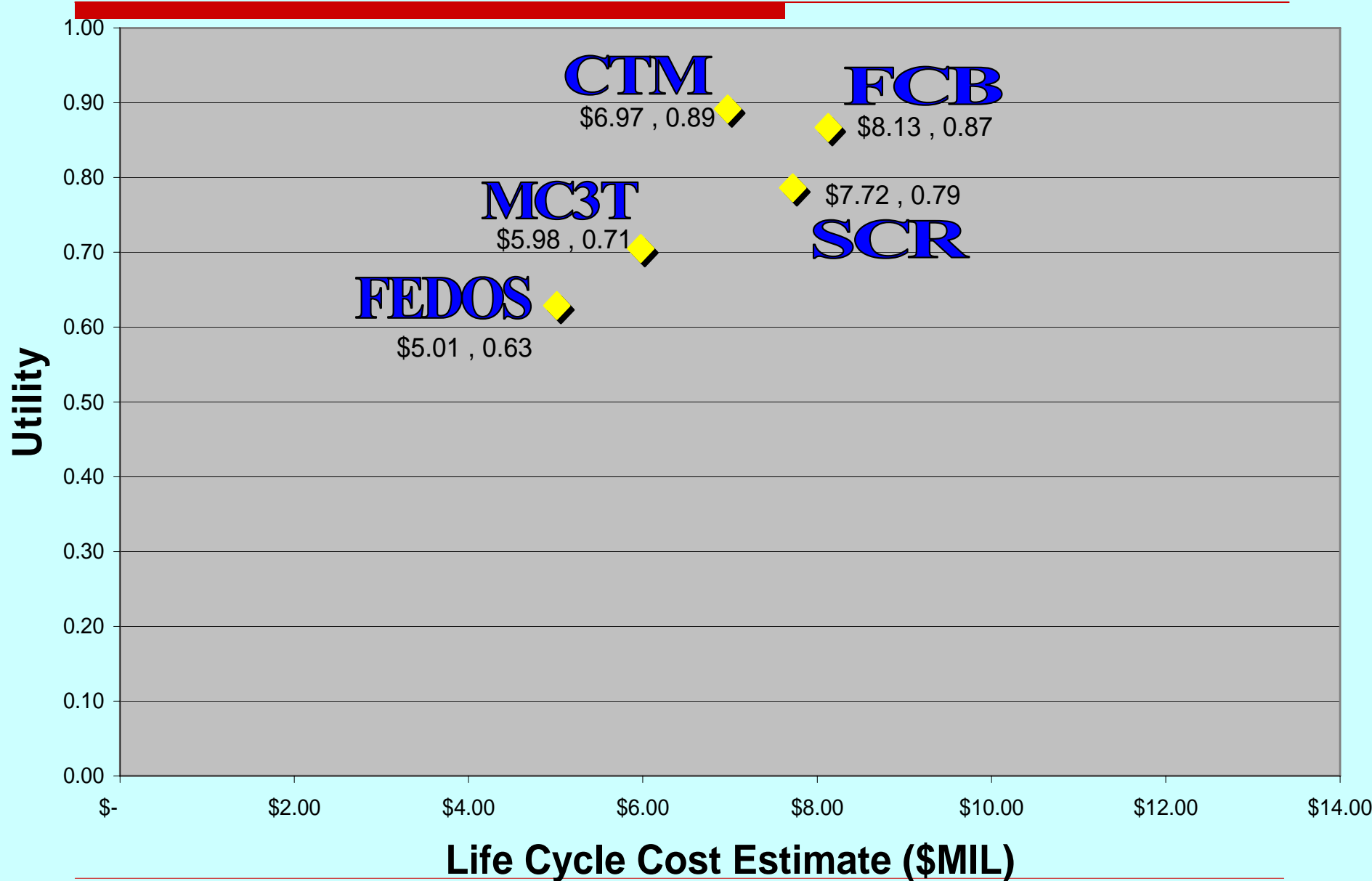



# LCCE vs Utility

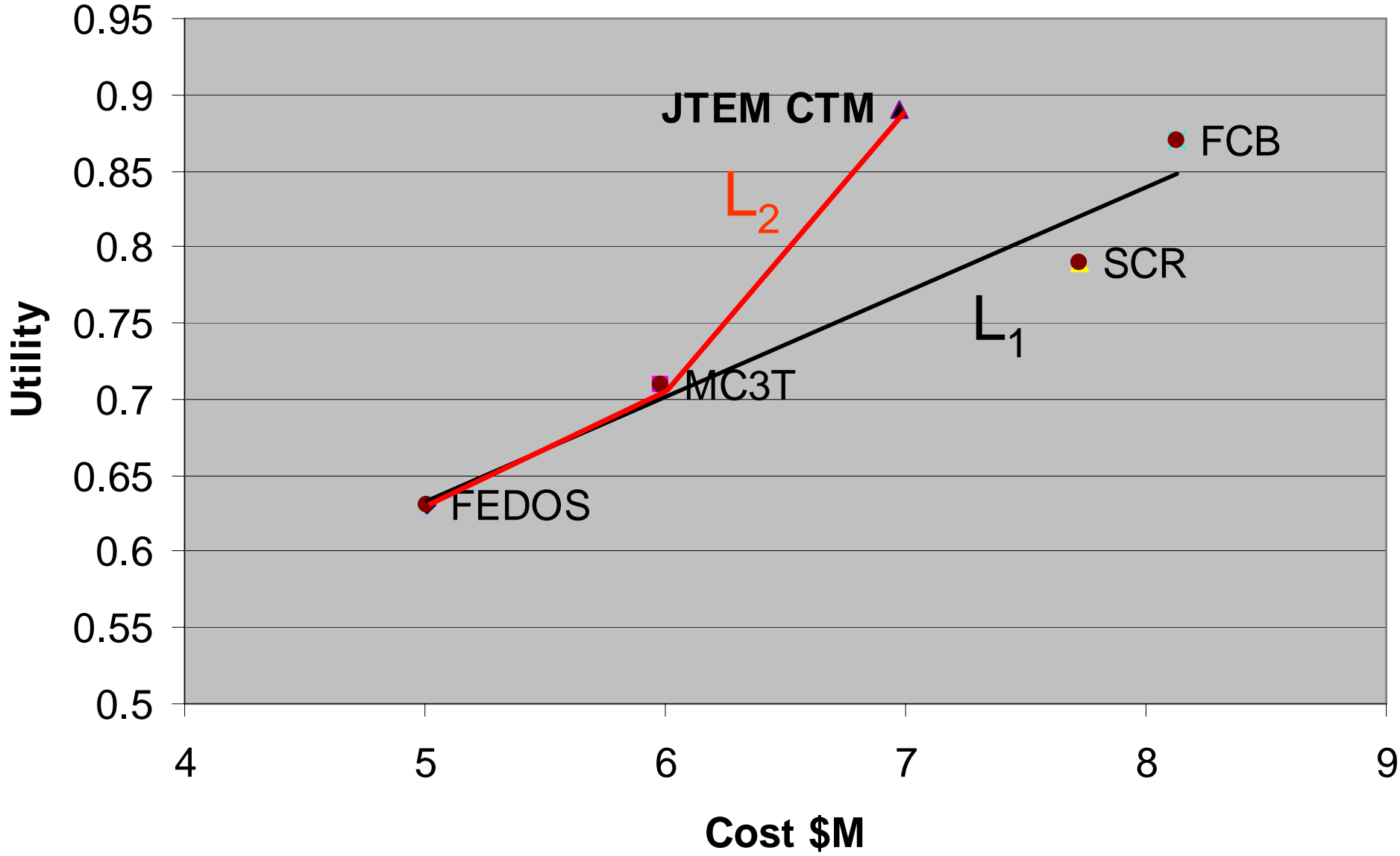

# Way Ahead: 3 areas

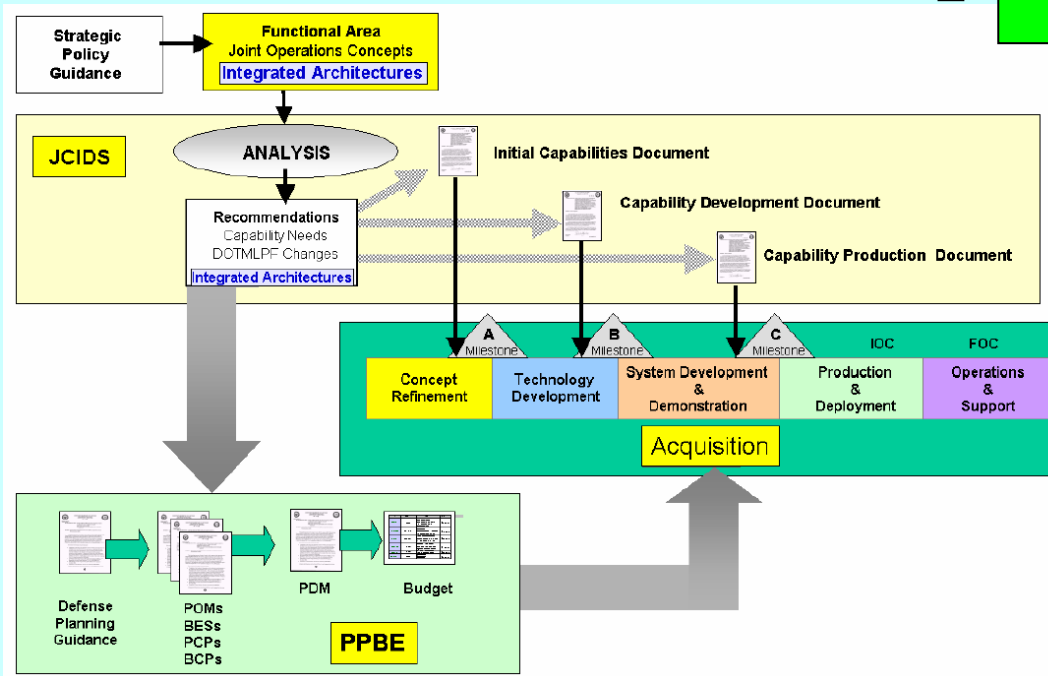
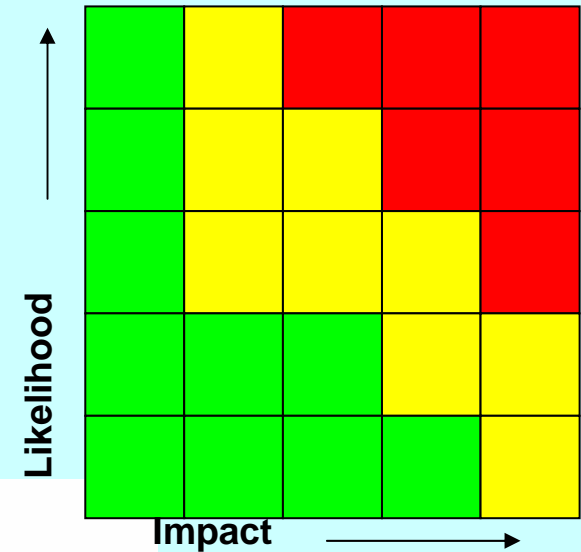
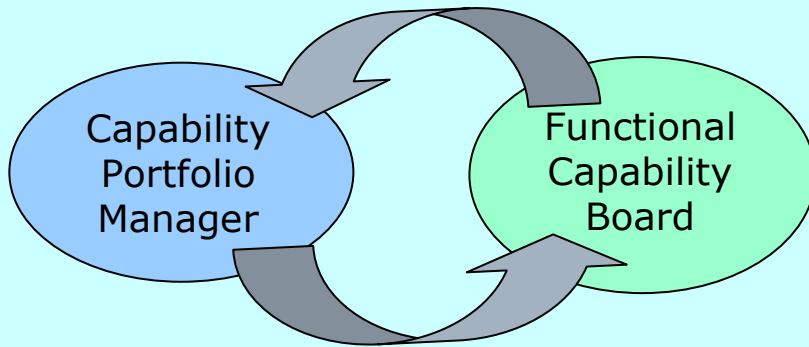

# Back-Up



# References



- About.com: Economics, "Definition of Elasticity."  
[<http://economics.about.com/cs/economicsglossary/g/elasticity.htm>]. August 2007.
- Air Force Manual 63-119, *Certification of System Readiness for Dedicated Operational Test and Evaluation*, February 1995.
- Armed Forces Communications and Electronics Association, "Marines Build Transformational Bridge," *Signal Magazine*, April 2004.  
[[https://www.intel-alliance.org/signal/articles/templates/SIGNAL\\_Article\\_Template.asp?articleid=86&zoneid=35](https://www.intel-alliance.org/signal/articles/templates/SIGNAL_Article_Template.asp?articleid=86&zoneid=35)]. August 2007.
- Baker, S.L. Ph.D. "Simple Regression Theory I" notes for JSPM J716 (Quantitative Methods for Health Administration), University of South Carolina, Arnold School of Public Health, 2006. [<http://hadm.sph.sc.edu/Courses/J716/pdf/716%20Simple%20Regression%20Theory%20I.pdf>]. August 2007.
- Bao, J., Interview at Marine Corps Tactical Systems Support Activity, San Diego, California, and the JC3M team, 27 June 2007.
- Bjorkman, E. A. (a), Colonel, United States Air Force, "Joint Test and Evaluation Methodology," presentation given at MCTSSA, San Diego, California, January 2007.
- Bjorkman, E. A. (b), Colonel, United States Air Force, Phone Interview at Marine Corps Tactical Systems Support Activity, San Diego, California, and the JC3M team, 13 August 2007
- Blanchard, B.S. and Fabrycky, W.J., *Systems Engineering and Analysis*, 4<sup>th</sup> ed., Pearson Education Inc., 2006.
- Boeing Corporation "AGM-114 HELLFIRE Missile." [<http://www.boeing.com/history/bna/hellfire.htm>] August 2007.
- Bornman, L. G., "Command and Control Measures Of Effectiveness Handbook (C2MOE Handbook)," TRADOC Technical Document TRAC-TD-0393, U.S. Army Training and Doctrine Command (TRADOC) Analysis Center – Study and Analysis Center, Study Directorate, 1993.
- Buede, D. M., *The Engineering Design of Systems: Models and Methods*, John Wiley & Sons, Inc., 2000.
- Chairman of the Joint Chiefs of Staff Instruction 3170.01F, "Joint Capabilities Integration and Development System" May 2007.
- Chairman of the Joint Chiefs of Staff, "Interoperability and Supportability of Information Technology and National Security Systems" Chairman of the Joint Chiefs of Staff Instruction 6212.01D, Washington, D.C., March 2006.
- Chairman of the Joint Chiefs of Staff, "Joint Publication 6-02 Joint Communications System", Joint Chiefs of Staff, Washington, D.C., March 2006
- Chairman of the Joint Chiefs of Staff Manual 3500.04D, "Universal Joint Task List (UJTL)," August 2005.
- Chance, J., Interview at Marine Corps Tactical Systems Support Activity, San Diego, California, and the JC3M team, 27 June 2007.
- Chief of Staff of the Army, "Army Universal Task List (AUTL), Field Manual No. 7-15," Headquarters, Department of the Army, Washington, D.C., March 2005.
- Clemen, R. T. and Terence Reilly, *Making Hard Decisions with Decision Tools*, Brooks / Cole, 2001.
- Commandant of the Marine Corps, "Artillery Unit Training and Readiness Manual (Short Title Artillery T&R Manual)," Marine Corps Order 3501.26A, Washington, D.C., April 2000.
- "Cost Analysis Improvement Group Operating and Support Cost-Estimating Guide-Chapter 3," [<http://www.dtic.mil/pae/paeosg03.html>]. May 2007.
- Daniels, J., Werner, P. W., and Bahill, A. T., "Quantitative Methods for Tradeoff Analyses", *Systems Engineering*, vol. 4, Issue. 3, 2001.
- Defense Acquisition Guidebook, [<https://akss.dau.mil/dag/DoD5000.asp?view=document>]. Accessed August 2007.
- Department of Defense Civilian Personnel Management Service, "NSPS Pay table for Scientific and Engineering Group."  
[<http://www.cpmo.osd.mil/nsps/docs/SandE2007.pdf>]. June 2007.
- Department of Defense, Cost Analysis Improvement Group, "Operating and Support Cost-Estimating Guide," May 1992. [<http://www.dtic.mil/pae/>]. April 2007.
- Department of Defense Directive 5000.1, "The Defense Acquisition System," 12 May 2003.
- Department of Defense Instruction 7041.3, "Economic Analysis for Decision Making", November 1995.

# References

---



- England, G., *Capability Portfolio Management Test Case Roles, Responsibilities, Authorities, and Approaches*, Office of the Deputy Secretary of Defense, 2006.
- Federal Computer Week, "Pentagon Tests IT Portfolio Approach." [<http://www.fcw.com/article103409-08-06-07-Print&printLayout>] August 2007.
- Federal Information Processing Standards Publication, *Integration Definition for Function Modeling (IDEF0)*, p. 183, National Institute of Standards and Technology.  
[<http://www.itl.nist.gov/fipspubs/idef02.doc>]. August 2007.
- Feuchter, C. A., *Air Force Analyst's Handbook: On Understanding the Nature of Analysis*, U.S. Air Force Material Command, Office of Aerospace Studies, 2000.
- Finn, I., Interview at Marine Corps Tactical Systems Support Activity, San Diego, California, and the JC3M team, 23 February 2007.
- Forsberg, Mooz, Cotterman, *Visualizing Project Management*, John Wiley & Sons, Inc., 2000.
- Foster, T. and LaClava, G. "AHP or the Analytical Hierarchy Process: A Step by Step Approach."
- General Services Administration, "Schedule for Systems Engineering Support Service."  
[[https://www.gsaadvantage.gov/advgsa/advantage/search/search.do?BV\\_UseBVCookie=Yes&op=0&rq=system+engineering+support&sort=0&lmt=&vnd=&mf=&cat=ADV.S09&act=refine&sk=E2C17&q=00engineering+service+support](https://www.gsaadvantage.gov/advgsa/advantage/search/search.do?BV_UseBVCookie=Yes&op=0&rq=system+engineering+support&sort=0&lmt=&vnd=&mf=&cat=ADV.S09&act=refine&sk=E2C17&q=00engineering+service+support)]. July 2007.
- George, S. (a), "Comptroller Spending Plan" Marine Corps Tactical Systems Support Activity, Camp Pendleton, June 2007.
- George, S. (b), Interview at Marine Corps Tactical Systems Support Activity, San Diego, California, and the JC3M team, 27 June 2007.
- Hoesly, S., Interview at Marine Corps Tactical Systems Support Activity, San Diego, California, and the JC3M team, 27 June 2007.
- Hoivik, T. H., "Requirements Generation," presentation for OA4603 (Test and Evaluation), Naval Postgraduate School, 2007.
- Horn, B., Lieutenant-Colonel, "Complexity Squared: Operating in the Future Battlespace," *Canadian Military Journal*, pp. 8, Autumn 2003.
- International Council on Systems Engineering (INCOSE), 14 June 2004.
- Joint Publication 6-02, *Joint Communications System*, pp. viii – I-8, March 2006.
- Joint Test and Evaluation Methodology (JTEM) Joint Test and Evaluation (JT&E), *Capability Test Methodology (CTM) Method and Process (M&P) Model Description*, January, 2007.
- Joint Test and Evaluation Methodology (JTEM) Joint Test and Evaluation (JT&E), *Rock Drill Event Final Report*, Approved by Eileen A. Bjorkman, Colonel, USAF, 2007.
- Lockheed Martin UK - Integrated Systems & Solutions, Interoperable Systems Management and Requirements Transformation (iSMART).  
[[http://www.lm-isgs.co.uk/defence/cis\\_ismart.htm](http://www.lm-isgs.co.uk/defence/cis_ismart.htm)] August 2007.
- Manning, J. (a), *FEDOS Labor Hours Timesheet*, 2005.
- Manning, J. (b), "2005 FEDOS Technical Support Plan", MCTSSA, Camp Pendleton, June 2005
- Manning, J. (c), Interview at Marine Corps Tactical Systems Support Activity, San Diego, California, and the JC3M team, 27 June 2007.
- Marine Corps Tactical Systems Support Activity, 2005 FEDOS Technical Support Plan, 2005.
- Marine Corps Tactical Systems Support Activity, 2005 FEDOS Formal Evaluation Test Report, 2005.

# References

---



- McLean, T. (a), Major, United States Marine Corps, "Consolidated Requirements Assessment" Draft Version, CM#MC-0001, MCTSSA, Camp Pendleton, CA, June 2007.
- McLean, T. (b), Major, United States Marine Corps, Interview at Marine Corps Tactical Systems Support Activity, San Diego, California, and the JC3M team, 11 May 2007.
- McLean, T. (c), Major, United States Marine Corps, MC3T PAOM-001-V1 (Proof of Concept v2.3), July 13, 2007.
- Mitchell, M. and Jolley, J., *Research Design Explained*, 4<sup>th</sup> Edition, pp. 485-487, Earl McPeck, 2001.
- Nguyen, L., Interview at Marine Corps Tactical Systems Support Activity, San Diego, California, and the JC3M team, 27 June 2007.
- Office of Management and Budget, "Guidelines and Discount Rates for Benefit-Cost Analysis of Federal Programs", Circular No. A-94, October 1992.
- Office of Secretary of Defense, "Military Composite Pay and Reimbursements Rate Table." [<http://www.defenselink.mil/militarypay/pay>]. June 2007.
- Office of the Under Secretary of Defense for Acquisition Technology and Logistics, *Contract Pricing Reference Guides*, Volume 2, Chapter 9, 2005.
- Office of the Under Secretary of Defense for Personnel and Readiness, "Military Composite Pay and Reimbursements Rate Table." [<http://www.defenselink.mil/militarypay/pay>]. June 2007.
- Pariseau, Dr. R. and Oswald, Dr. I., "Using Data Types and Scales for Analysis and Decision Making," *Defense Acquisition Review Journal*, Spring 1994.
- Paul, Dr. R., Niewoehner, Dr. R., and Elder, Dr. L., *The Thinker's Guide to Engineering Reasoning*, The Foundation for Critical Thinking, 2006.
- Paulo, E. P. notes for SI4001 (Systems Engineering and Architecture), Naval Postgraduate School, 2005.
- Pershing, J. A., PhD, *The Design and Development of Survey Instruments*, Performance Technology Center Yorktown Virginia by Education and Management Research Associates, Bloomington, Indiana, September 26, 2000.
- Saaty, T. L., *Fundamentals of Decision Making and Priority Theory with the Analytic Hierarchy Process*, Analytic Hierarchy Process Series, Vol. 6, RWS Publications, 1994.
- Saxton, J., Congressman, "C4I Interoperability for our Warfighters," *Military Information Technology*, Issue 10, Volume 7, December 2003.
- Schaeffer, M., "Next Generation Systems Engineering and the CMMI," paper presented at the 3rd Annual CMMI Technology Conference & User Group, Denver, Colorado, November 2003.
- Stevens, R., et. al., *Engineering: Coping with Complexity*, Prentice Hall, Europe, 1998.
- Verma, Dr. D., "Executing Systems Engineering on Programs," paper presented at the International Council on Systems Engineering (INCOSE) Enchantment Chapter meeting, Albuquerque, New Mexico, March 2006.
- Villar, M. (a), Major, United States Marine Corps, "Requirements for Members of the Marine Corps Tactical Systems Support Activity Self Assessment Team", Aug 6, 2007.
- Villar, M. (b), Major, United States Marine Corps, Interview at Marine Corps Tactical Systems Support Activity, 11 May 2007.
- Whitten, J. L. and Bentley, L. D., *Systems Analysis and Design Methods*, 7<sup>th</sup> ed., McGraw-Hill/Irwin, 2007.
- Wilson, J. P., Deputy Chief, Methods and Processes Division Joint Test and Evaluation Measures, Joint Test and Evaluation Center, telephone conversation between Wilson and team members, 03 August 2007.
- Wymore, A.W., *Model-Based Systems Engineering*, CRC Press, 1993.

# Refined Problem Statement



"There is no system that defines and compares System of System performance measures to war-fighter needs in an objective and measurable way."

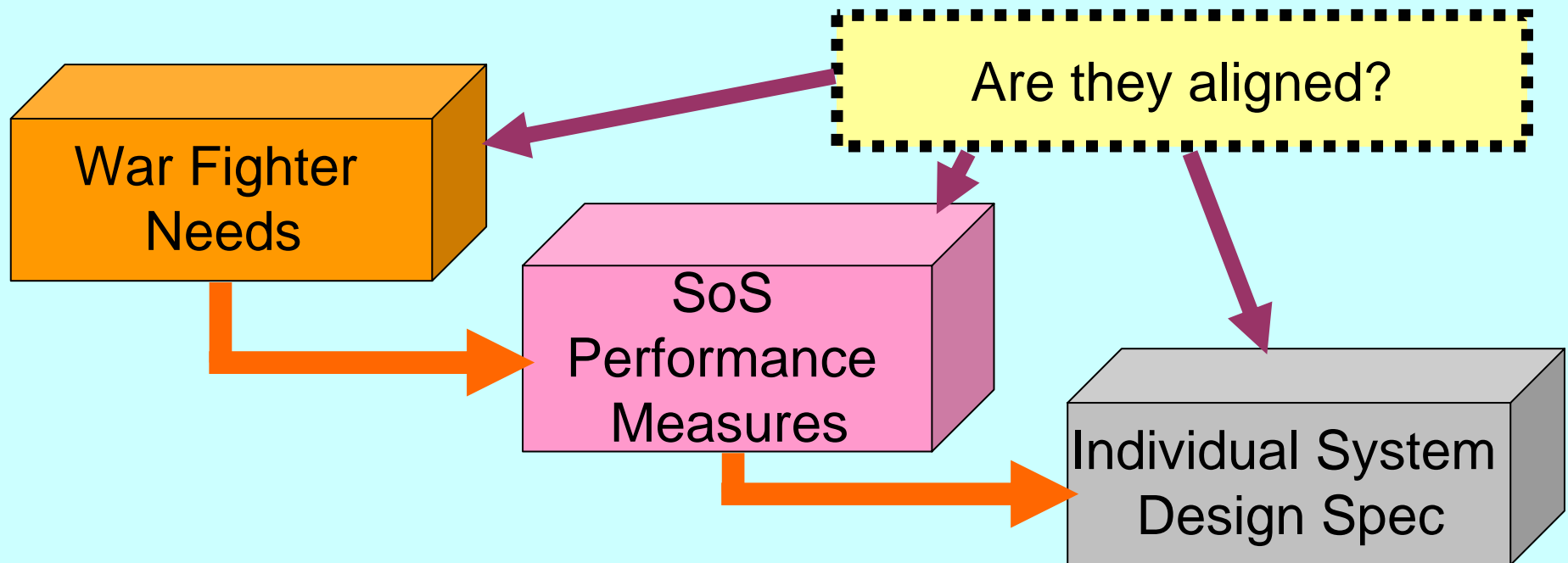

# Federation Of Systems (FEDOS)



**Service Test Organization**

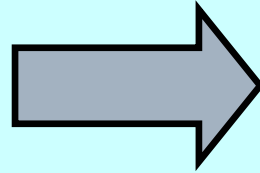

**System Requirements  
System Test Plan  
System Test Procedures**

Elicit Requirements from Service Stakeholders for each event:

“AFATDS must display unit symbology”

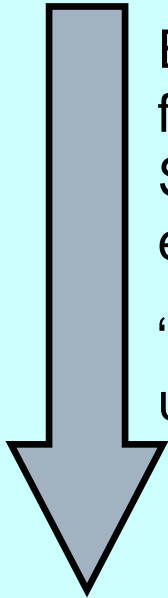

**Service System “Owners”**

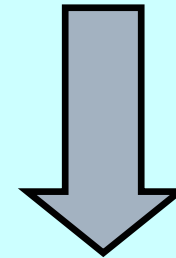

**System-Centric Testing**

**Did AFATDS report ammo status correctly?  
Did EPLRS transmit firing data?**



# Marine Air Ground Task Force C4I Capability Certification Test (MC3T)



**Service Test Organization**

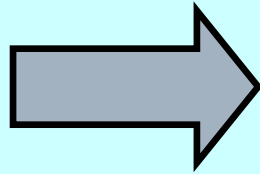

**SoS Capability Assmt Plan  
SoS Performance Measures**



Capabilities Package from Stakeholders for each event:

“AFATDS must send msg to TBMCS...”

**Service Doctrine Developers  
System “Owners”**

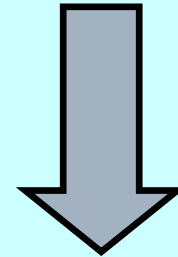

**SoS Capability Assessment**

**Was Call For Fire:  
Timely  
Reliable  
Accurate...**



## Joint Test Organization

Review Joint Doctrine, CONOPS, System Documentation for each event

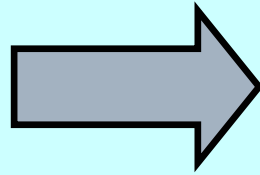

## Pgm Introduction Doc:

- SoS, SUT, Environment, JOC, COI, MOP, MOE
- SoS Evaluation Strategy

## Test Plan

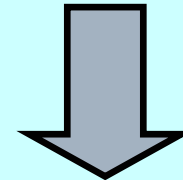

## SoS Capability Assessment

Was Call For Fire effective in a Joint Mission environment?  
Is XXX an appropriate investment?

# Functional Capabilities Board (FCB)



**Joint Test Organization**

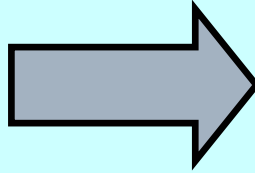

**SoS Performance Measures  
SoS Test Plan  
SoS Test Procedures**

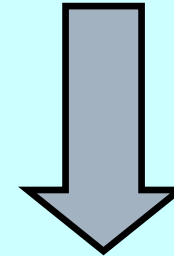

**SoS Capability Evaluation**

**Was speed (accuracy, effectiveness, efficiency...) improved, unchanged, or degraded?**

Define SoS Performance Measures (ongoing)

**JCIDS C2 FCB, System Documentation**

# System Capabilities Review (SCR)



## Joint Test Organization

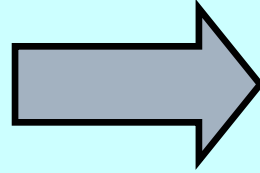

**SoS Performance Measures**  
**SoS Test Plan**  
**SoS Test Procedures**

Review Joint  
Doctrine,  
CONOPS, System  
Documentation for  
each event

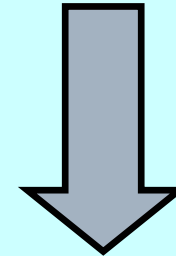

**SoS Capability  
Evaluation**

**Was speed (accuracy,  
effectiveness, efficiency...)  
improved, unchanged, or  
degraded?**

# Blank Scoring Matrix



	Percentage of Traceable Measures	Days to Plan Evaluation	Quality of Planning Outputs	Elasticity of Labor	Elasticity of Duration
<b>Alternatives</b>	<b>1.3.2</b>	<b>1.4.3</b>	<b>1.4.3</b>	<b>4.1</b>	<b>4.1</b>
FEDOS					
MC3T					
JTEM CTM					
FCB					
SCR					

# CORE

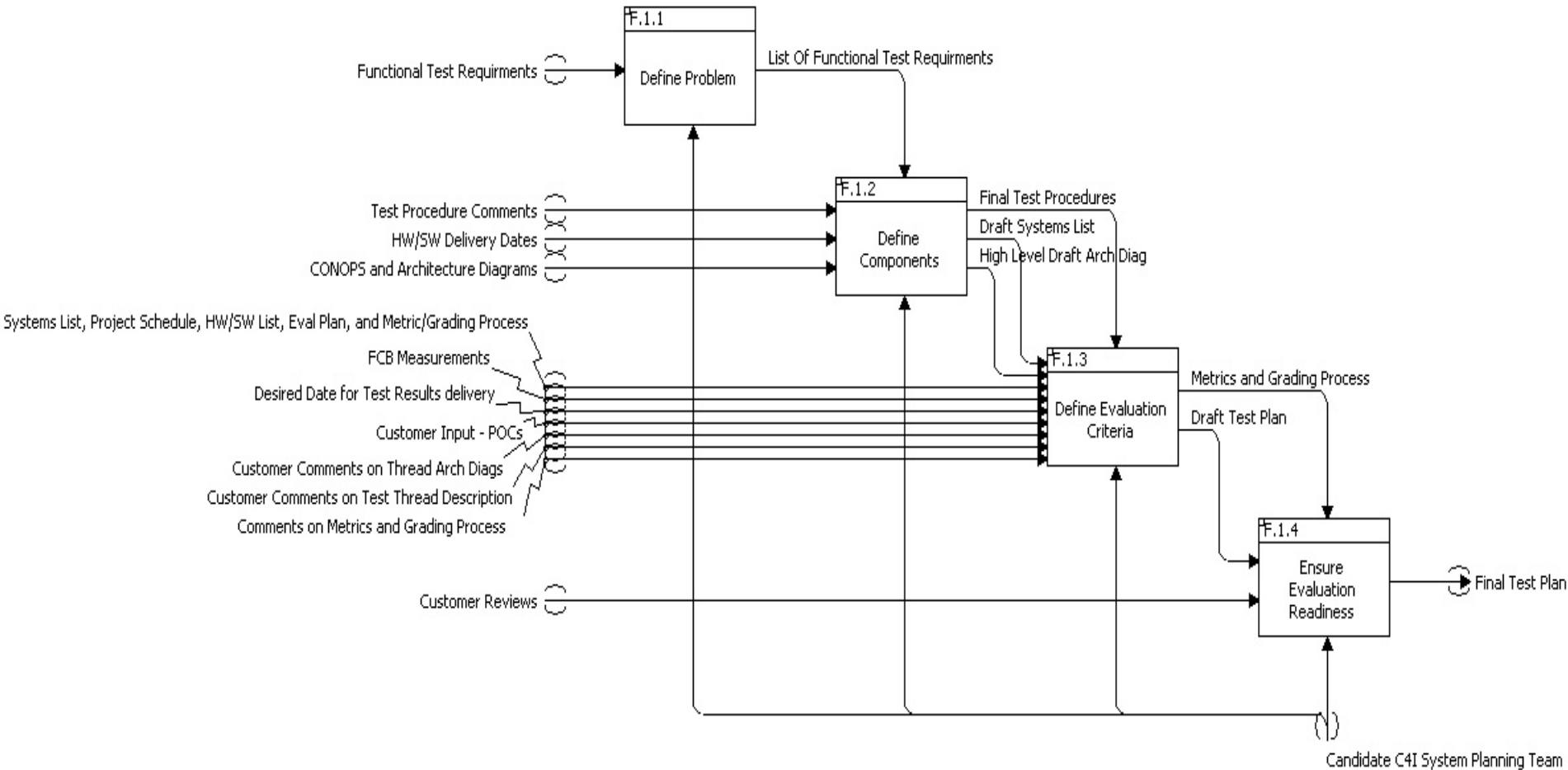

# POW-ER

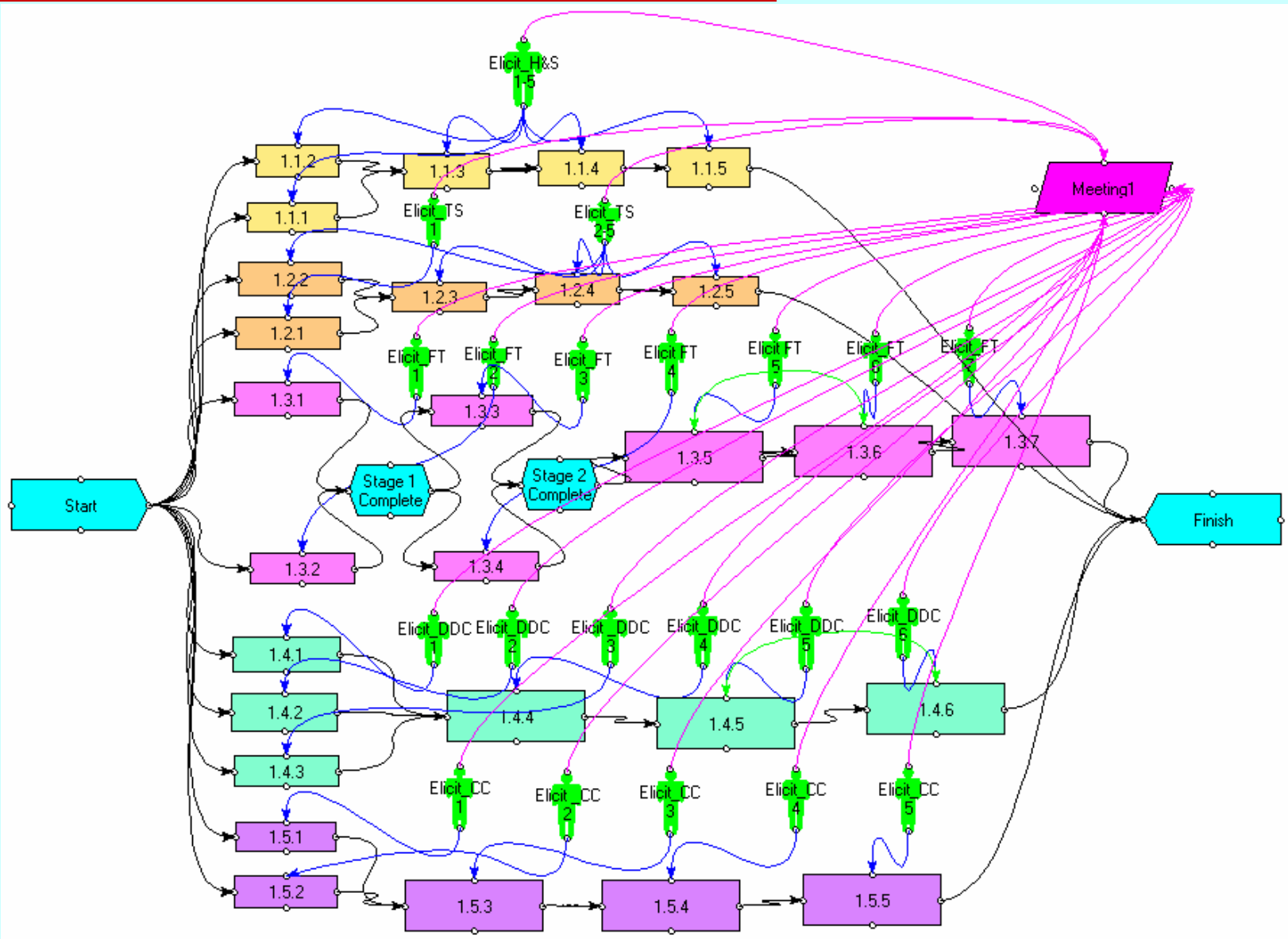

## Baseline Planning Process Model

To validate this model with real-world Man hours, use 19 Systems, 4 New Capabilities, and 10 Old Capabilities  
Output needs to be within 5% of: 6,482 TotalTime in Man hours

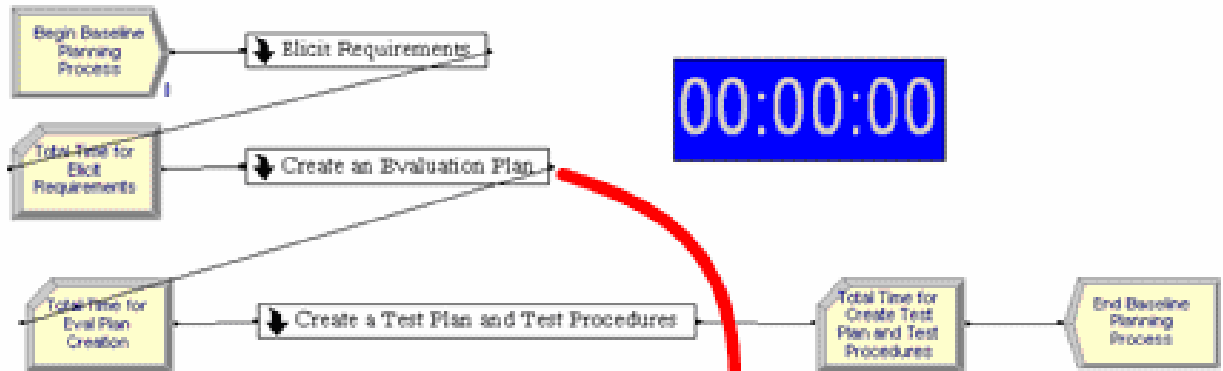

### Create an Evaluation Plan Submodel

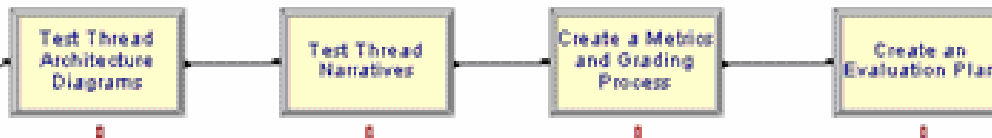



# Conclusions

---



- JTEM CTM “wins”
  - Highest score, but . . .
  - . . . not by much
- JTEM CTM cost
  - High development: \$3.5M vs \$2.3M
  - Lowest O&S: \$121,000/year